

Annual Report 2017

NMFS IPA No. 2



Chinook Salmon Bycatch Reduction

Incentive Plan

March 15, 2018

IPA Representative

Stephanie Madsen
At-sea Processors Association
P.O. Box 32817
Juneau, AK 99803
(907) 523-0970
smadsen@atsea.org

Technical Representative

Karl Haflinger
Sea State, Inc.,
P.O. Box 74
Vashon, WA 98070
(206) 463-7370
karl@seastateinc.com

Table of Contents

| | |
|--|-----------|
| Introduction..... | 3 |
| CP IPA Overview..... | 4 |
| Incentive Measures | 5 |
| The Chinook and Chum Rolling Hot-Spot (RHS) Program | 5 |
| Cumulative Chinook Bycatch Performance | 6 |
| Chronic Vessel Poor Bycatch Performance..... | 7 |
| Chinook Protection Priority..... | 7 |
| Chinook Salmon Conservation Areas..... | 7 |
| Management of Vessel Allocations..... | 9 |
| CP IPA Allocations and Catches for 2017 | 10 |
| Effects of Incentive Measures | 13 |
| Chinook Bycatch Avoidance Behavior | 18 |
| Chum Salmon Bycatch Avoidance Behavior | 21 |
| Chinook PSC Rates in October | 22 |
| Ongoing Gear Research and Development..... | 22 |

List of Tables

| | |
|---|-----------|
| Table 1. CP IPA Day-One Allocations of Pollock and Chinook Salmon, 2017, Including CDQ Pollock and Chinook Allocated to the CP Fleet from CDQ Partners. | 10 |
| Table 2. Transfers of pollock and Chinook between CP IPA vessels in 2017. | 11 |
| Table 3. CP IPA Pollock Catch and Chinook Bycatch Performance by Season and Vessel, 2017..... | 13 |
| Table 4. Chinook Bycatch Rates (n/mt) in the CP Fleet for 2006-2010 and 2013-2017..... | 14 |
| Table 5. Number of CP vessels excluded from designated Chinook bycatch avoidance areas during the 2017 A-season. | 20 |
| Table 6. Number of CP vessels excluded from chum salmon designated bycatch avoidance areas during the 2017 B-season..... | 22 |

List of Figures

| | |
|---|-----------|
| Figure 1. A-season Chinook Conservation Area..... | 8 |
| Figure 2. B-season Chinook Conservation Areas..... | 9 |
| Figure 3. September-February CP Vessel Chinook Bycatch Rate Distribution by year 2003-2018..... | 15 |
| Figure 4. A-Season CP Vessel Chinook Bycatch Rate Distribution for 2009-2010 (top) with variance of 0.011 and 2016-2017 (bottom) with variance of 0.007. | 16 |
| Figure 5. A-Season CP Vessel Chinook Bycatch Rate Frequency Distribution for 2017..... | 17 |
| Figure 6. Fleetwide Chinook bycatch ratio distribution for 2017 fishing seasons. | 18 |
| Figure 7. Pollock CP trawl locations between September 1st and February 28th for the years 2000-2010 (blue), 2011-2017 (orange). Darker color indicates higher Chinook bycatch rates. | 19 |
| Figure 8. Chinook bycatch avoidance areas for the CP sector, A-season, 2017..... | 20 |
| Figure 9. Chum bycatch avoidance areas for the CP sector during June, July and August, 2017. | 21 |

Introduction

Amendment 91 to the Bering Sea and Aleutian Islands Groundfish Fishery Management Plan (BSAI FMP) limits Chinook salmon bycatch in the eastern Bering Sea (EBS) pollock fishery. The rules and regulations implementing Amendment 91 came into force at the start of the 2011 fishery. Amendment 91 is an innovative approach to managing Chinook salmon bycatch in that it combines a prohibited species catch (PSC) limit on the amount of Chinook salmon that may be caught incidentally by the fishery with an incentive plan agreement (IPA) and performance-standard requirement designed to minimize bycatch to the extent practicable in all years. The approach is designed to motivate fishery participants to avoid Chinook salmon bycatch at the individual vessel level under any condition of pollock and Chinook abundance in all years. The vessel-level incentives are created through contracts among the fishery participants.

Amendment 110 to the BSAI FMP expanded the rules and regulations established under Amendment 91 by creating a comprehensive salmon bycatch avoidance plan. Amendment 110 requires incentives for the operator of each vessel to avoid Chinook **and** chum salmon bycatch under any condition of pollock and Chinook salmon abundance in all years. Under Amendment 110, the Chinook limits established by Amendment 91 will be reduced in years of low Chinook abundance in Western Alaska as determined by a 3-river index. Amendment 110 also requires: (1) the use of salmon excluder devices; (2) penalties for vessels with consistently higher Chinook salmon PSC relative to other vessels fishing at the same time; and (3) fishing restrictions or performance criteria to ensure that Chinook salmon PSC rates in October are not significantly higher than in prior months. The rules and regulations implementing Amendment 110 came into force at the start of the 2017 fishery.

The 50 CFR 679.21(f)(13) stipulates that IPA entities report annually on the following:

- Incentive measures, including the rolling hot spot program and salmon excluder use, in effect in the previous year;
- How incentive measures affected individual vessels;
- How incentive measures affected salmon savings beyond current levels;
 - Effectiveness of measures to ensure that chum salmon were avoided in areas and times where chum salmon are likely to return to western Alaska
 - Effectiveness of restrictions that target vessels that consistently have significantly higher Chinook PSC rates relative to other vessels
 - Effectiveness of restrictions used to ensure that Chinook PSC rates in October are not significantly higher than in prior months
- IPA amendments approved by NMFS since the last annual report and the reasons for amendments;
- Sub-allocation to each participating vessel;
- Number of Chinook PSC and amount of pollock (mt) at the start of each fishing season;
- Number of Chinook PSC and amount of pollock (mt) caught at the end of each season;
- In-season transfers among entities of Chinook salmon PSC or pollock among AFA cooperatives;
- Transfers of Chinook salmon PSC and pollock allocations among IPA vessels.

CP IPA Overview

The Catcher-Processor--Chinook and chum salmon bycatch reduction--Incentive Plan Agreement (CP IPA) is designed to provide the incentives necessary to achieve the goals and objectives of Amendment 91 and 110. The plan builds on experience gained in the development and refinement of time-and-area-based, rolling hot-spot avoidance programs. The plan creates incentives to avoid salmon bycatch by restricting the pollock fishing opportunities of vessels with poor Chinook and/or chum bycatch performance while allowing vessels with good performance increased access to the fishing grounds. Losing access to good pollock fishing raises vessel operating costs and reduces product values. Avoiding grounds restrictions reduces operating costs and allows for the production of higher-valued products (especially during the A-season), thus increasing profits.

The Chinook bycatch limits depend on whether the fishery participants develop IPAs. If IPAs are developed and the 3-river (Yukon, Kuskokwim, and Unalakleet) combined run reconstruction total (3-river index) is determined to be above 250,000 Chinook, then the annual PSC limit in the subsequent year is 60,000 Chinook during any two-out-of-seven years, and 47,591 Chinook in other years. If IPAs are developed and the 3-river index is below 250,000 Chinook, then the subsequent years' annual PSC limit is 45,000 Chinook during any two-out-of-seven years, and 33,318 Chinook in other years. During 2017 the 3-river index was determined not to be in low abundance and all pollock vessels participated in an IPA. The catcher-processor (CP) sector IPA participants included vessels harvesting the American Fisheries Act (AFA) CP Sector and Community Development Quota (CDQ) pollock allocations. For the CP sector, the Chinook PSC limit is 17,040 fish (under the 60,000 fish annual limit) and the pollock quota is 36 percent of the non-CDQ directed fishing allocation. For the CDQ sector, the Chinook PSC limit is 4,896 fish (under the 60,000 fish annual limit) and the pollock quota is 10 percent of the annual directed fishing allocation. Each year the CP IPA participants manage Chinook bycatch using the lower 47,591 fishery (33,318 in low abundance years) "performance standard" limit. Under the performance standard, the CP sector Chinook quota is 13,516 fish and the CDQ sector Chinook quota is 3,883 fish. These pollock and Chinook quotas are further allocated among the seasons and the participating vessels. Table 1 shows the CP IPA "day-one" allocations of pollock and Chinook salmon PSC quota for 2017.

The IPA is designed to provide an incentive for good vessel Chinook and chum bycatch performance under any condition of pollock and Chinook salmon abundance. Primary IPA components include: (1) data gathering, monitoring, reporting, and information sharing; (2) identification of bycatch avoidance areas (BAA); and (3) fishing-area prohibitions for vessels with poor bycatch performance. Additional components include: (4) an A-season closed area of approximately 755 square nautical miles on the northern flank of the Bering Canyon; and (5) a set of conditional, B-season closed areas of approximately 1,295 square miles along the outermost EBS shelf. Vessels are prohibited from fishing in the B-season areas beginning on October 15th and continuing through the end of the season during years when the aggregate bycatch of all plan vessels during the month of September exceeds a preset threshold.

Incentive Measures

THE CHINOOK AND CHUM ROLLING HOT-SPOT (RHS) PROGRAM

One of the most practical and direct methods to create incentives to avoid salmon bycatch is to limit the pollock fishing opportunities of a vessel when bycatch performance is poor. This simple approach works especially well for catcher-processors because efficient processing requires an uninterrupted flow of fish, and this can be achieved most reliably with unrestricted access to the grounds. Because experience has shown that high, local concentrations of pollock may often be found where concentrations of salmon are also high (the vessels can “see” the pollock but not the salmon), limiting access to local areas of relatively high Chinook and chum bycatch is an efficient way to create a financial incentive to avoid salmon bycatch. This is because losing access to good pollock fishing grounds increases vessel operating costs and reduces the amount of products that can be produced during a day of fishing. A vessel that retains nearly unrestricted access to good pollock fishing opportunities avoids costs associated with moving and finding pollock in other areas, and so the vessel can produce higher volumes of higher valued products each day.

The RHS accomplishes this in two steps. The first step is to employ data gathering, reporting, and information sharing to identify local areas of relatively high Chinook and chum abundance on the pollock grounds. Pollock catch and Chinook and chum bycatch records from all fishery participants are gathered, compiled, evaluated, and distributed to IPA participants each week during which an IPA vessel catches pollock. With this information, areas of relatively high Chinook and chum bycatch are identified (hot-spots, or bycatch avoidance areas; BAA). BAA for chum are only identified during the B-season, while BAA for Chinook can occur in both A and B seasons. Should vessels continue to fish in these areas, high salmon bycatch is likely to occur because local concentrations of salmon routinely persist in time and space for several weeks. Access to this information in real time allows vessels to decide where or where not to fish based on where salmon are likely to be concentrated. Data shows that CP vessels are using the information provided through this program to avoid fishing in a BAA, even when not required to do so under the provisions of the IPA. This is demonstrated in more detail under ‘Effects of Incentive Measures’ below.

The second step is to evaluate vessel Chinook and chum bycatch performance relative to a grounds-wide index of Chinook and chum abundance (the base rate). This base rate fluctuates depending on average vessel performance to reflect the “base” level of Chinook and/or chum abundance on the grounds. The base rate is calculated as the grounds-wide number of Chinook or chum caught per ton of pollock caught. Because the base rate fluctuates depending on pollock and salmon abundance, benchmarking vessel performance against this rate establishes and maintains incentives to avoid salmon bycatch under any condition of pollock and Chinook abundance. The bycatch performance of an IPA vessel must remain below 75% of the base rate in any given week in order for it to maintain unrestricted access to the fishing grounds (i.e. to not be prohibited from fishing in any BAA). The incentive plan components to implement data gathering, reporting, and information sharing to identify areas of relatively higher chum salmon bycatch on the pollock grounds are the same as those used for Chinook salmon, except: 1.) Bycatch Avoidance Areas are identified such that priority is given to areas and times when

chum salmon are most likely to return to Western Alaska rivers, and 2.) Chinook protection priorities eliminate chum salmon avoidance measures in areas and times when Chinook avoidance measures take priority. More information about BAA identification methods for both Chinook and chum salmon are detailed within the amended IPA agreement:

<https://alaskafisheries.noaa.gov/sites/default/files/cpamdpacket2016.pdf>.

Vessel performance (number of Chinook per ton of pollock caught) is measured both currently (most recent two weeks) and cumulatively (over the entire fishing season), relative to the base rate. Vessel performance over these time periods is used to create two different incentives. To evaluate current performance, vessel performance is measured during the prior two weeks and compared to the base rate. A two-week period is used because experience has shown that day-to-day vessel bycatch performance is influenced by random factors associated with changes in weather, winds, water temperatures, and currents, and measuring performance over a two-week period dampens the effects of these random influences. This increases the usefulness of the performance measure in the creation of an incentive for the individual vessel to avoid bycatch.

The IPA rules stipulate that if the current bycatch performance of an IPA vessel is not lower than 75% of the base rate, then the vessel is prohibited from fishing in the identified BAA for seven days (i.e. the following week). If during the following week the current bycatch rate of a vessel operating under a fishing prohibition remains higher than 75 percent of the base rate, then the vessel is prohibited again from fishing in the BAA for an additional seven days. A seven-day fishing prohibition is called a weekly fishing prohibition.

CUMULATIVE CHINOOK BYCATCH PERFORMANCE

The cumulative Chinook bycatch performance of a vessel is measured as the total amount (number) of Chinook salmon bycatch by the vessel during the fishing year relative to the pollock allocation assigned to that vessel (Table 1 shows the “day-one” assignments for 2017). So the measure of cumulative vessel performance accumulates from the first day of fishing through to the last, and is evaluated against a standard designed to magnify the incentive to avoid salmon bycatch during years when the baseline abundance of Chinook is medium and high. Based on analysis of more than a decade of CP catch records, an annual bycatch of 8,500 Chinook indicates a year when Chinook abundance on the grounds traditionally fished by CP vessels is at a medium level, and this number of bycatch Chinook is the basis for the cumulative performance incentive.

Cumulative bycatch performance is evaluated for those vessels that receive a weekly fishing prohibition. For these vessels, if cumulative Chinook bycatch is higher than the medium-abundance standard, then the vessel is prohibited from fishing in the BAA for two weeks. This standard is called the vessel cumulative bycatch amount, and a fourteen-day fishing prohibition is called an extended fishing prohibition. If vessel Chinook bycatch is greater than its cumulative amount, then it is subject to the extended fishing prohibition. Additional information about how the vessel cumulative amount is determined is in the IPA agreement.

CHRONIC VESSEL POOR BYCATCH PERFORMANCE

An incentive to avoid chronic vessel poor bycatch performance was added to the CP IPA in 2015 in advance of the Amendment 110 requirement. This incentive identifies vessels with poor bycatch performance by comparing relative vessel performance over several pollock seasons. At the end of each season, vessels with bycatch performance (Chinook salmon per ton of pollock catch) greater than one and one-half (1.5) standard deviations above the average vessel performance are identified. If a vessel is so identified during three consecutive seasons, then the vessel is designated a poor performance vessel during the following season. All vessels designated as poor performers are prohibited from fishing in any BAA for the entire season. If the following season is a B-season, then these vessels are also prohibited from fishing in the B-season Chinook Salmon Conservation Areas during October. While this provision is designed to identify and penalize chronic poor performers, an incentive for all vessels to improve Chinook bycatch performance is created as all vessels change fishing behavior to avoid being designated a poor performance vessel.

CHINOOK PROTECTION PRIORITY

The Chinook protection priority eliminates chum salmon avoidance incentives during September and October, a period when Chinook abundance on the grounds usually increases. Because in the fall, Chinook often appear first within the Bering Canyon while chum salmon may still be on the fishing grounds to the northwest, the plan may, for example, adopt Chinook BAA east of 168 degrees West longitude while preserving BAA for chum salmon west of 168 degrees West longitude. The Chinook protection priority was conceived to ensure that the incentives to avoid chum salmon during the B-season do not increase Chinook salmon bycatch.

CHINOOK SALMON CONSERVATION AREAS

Chinook salmon feeding migrations produce concentrations of Chinook in discrete, local areas along the EBS outer continental shelf, and many of these areas are well known to pollock fishermen. The areas are known to pollock fishermen because more often than not high concentrations of pollock are found in the areas. However, the precise times during which pollock and Chinook may be concentrated in any local area depends on a host of environmental and physical-oceanographic conditions that change with the seasons and the weather, such that it is not generally possible to know precisely when and where pollock and Chinook are concentrated together before going fishing for pollock.

Analysis of catch records over a decade or more has revealed the existence of one area along the outer continental shelf within which it seems that high concentrations of Chinook salmon exist almost every year during the winter fishery. Based on this analysis, an A-season fishing prohibition within an approximately 735 square mile area is included in the plan as a means to reduce bycatch. The area is called the A-season Chinook Salmon Conservation Area (CSCA; maps and the latitude and longitude coordinates of all CSCA boundaries are provided in the IPA agreement). Figure 1 shows the boundaries of the A-season CSCA.

Analysis of B-season catch records over two decades shows that when migrating Chinook arrive on the outer continental shelf in sufficient numbers during September, the odds that the fishery will

encounter high concentrations of Chinook in October appear to increase. To create an incentive to reduce bycatch during the latter portion of the B-season, the CP IPA includes “triggered” fishing prohibitions for three areas of approximately 1,295 square miles along the outermost shelf. These areas are called the B-season Chinook Salmon Conservation Areas (Figure 2). To implement the incentive, all vessels are prohibited from fishing in the areas beginning on October 15th and continuing through to the end of the season during those years when the aggregate bycatch rate for all vessels during the month of September exceeds 0.015 Chinook per metric ton of pollock catch. This performance criteria ensures that Chinook salmon PSC rates in October are not significantly higher than those achieved in the preceding months.

The CP IPA also includes financial penalties for violating a BAA prohibition or for fishing in a CSCA when fishing there is prohibited. These penalties are \$10,000 for the first violation, \$15,000 for a second violation, and \$20,000 for the third and each subsequent violation during the fishing year, with every trawl inside a prohibited area considered a separate violation.

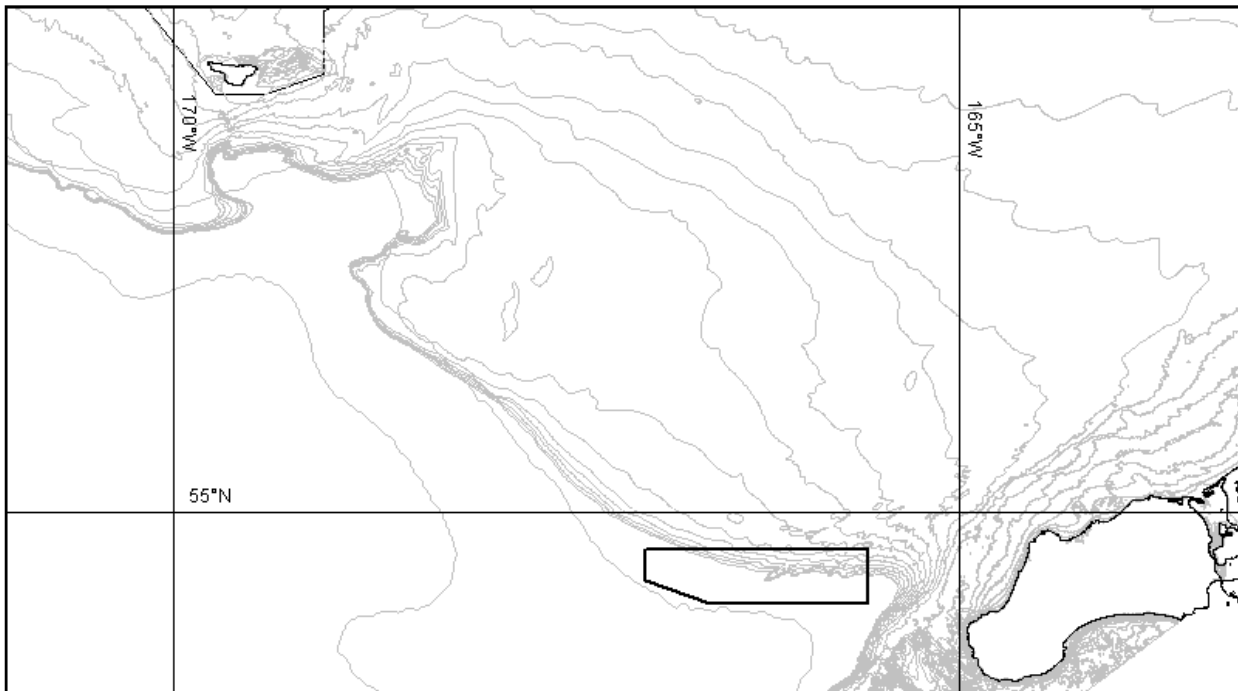

Figure 1. A-season Chinook Conservation Area.

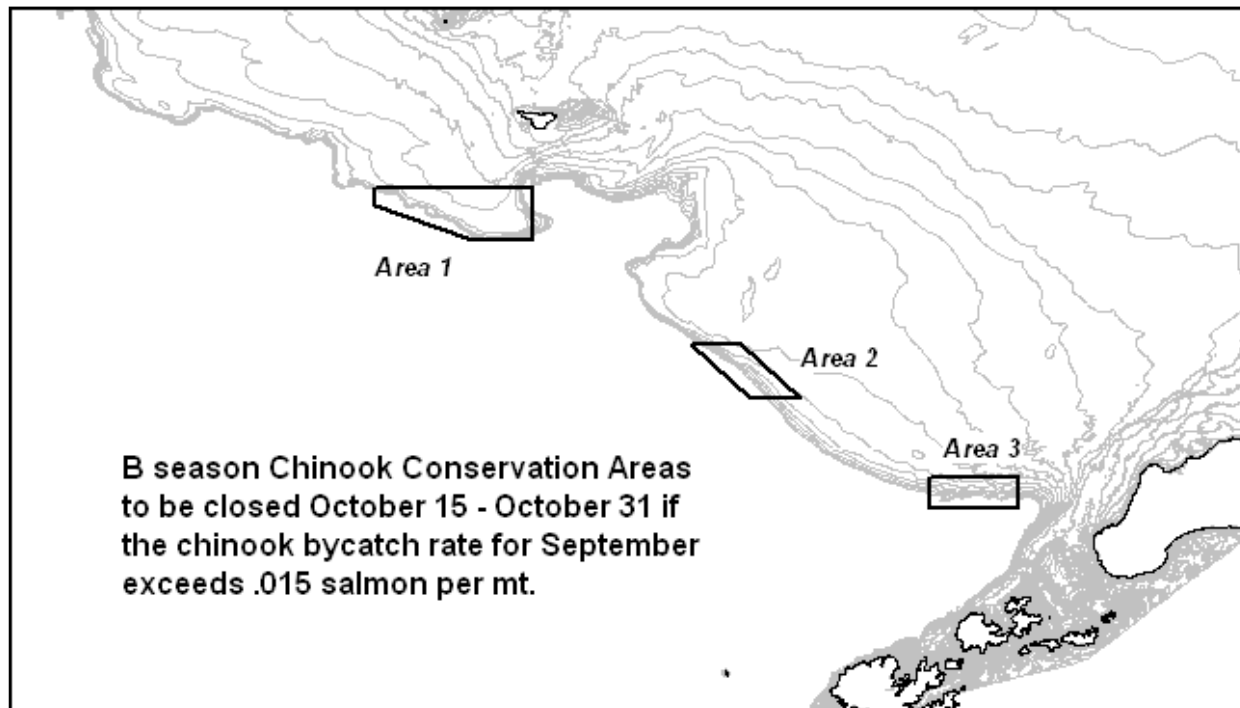

Figure 2. B-season Chinook Conservation Areas.

Management of Vessel Allocations

As discussed in the overview of the CP IPA, Amendment 91 establishes a total Chinook salmon cap of 60,000, with a performance standard of 47,591 Chinook with those amounts lowered in the event of a low-abundance 3-river index as outlined by Amendment 110. If the performance standard is met or exceeded in 3 of 7 consecutive years, then AFA vessels are held to the lower performance standard in perpetuity. Therefore the CP IPA is structured so that the absolute cap of 60,000 (in non-low-abundance years) is never allocated among companies and vessels, unless the CP Salmon Corporation calls a vote and that vote is majority in favor. Instead, the allocation to companies and vessels always starts with the CP portion of the 47,591 performance standard, or 13,516 Chinook. First buffers are subtracted from this 13,516 Chinook, and then the remaining Chinook are allocated by the entity to companies who must then allocate them to their respective vessels before the start of fishing for the year. No company or vessel has received a re-allocation of Chinook salmon from the buffer since the IPA inception.

The CP IPA is designed to work in concert with the bycatch allocation management activities of the entities authorized within Amendment 91 and 110 to perform this task. For example, the plan includes a requirement for the constitution of a limit buffer to ensure that the sector bycatch limits established by Amendment 91 and 110 are conserved. The buffer is made up of contributions from all plan vessels in amounts equal to at least two-thirds of one percent of the vessel Chinook allocation. Because the limit buffer is planned to address some unexpected, unknown event, it is anticipated that the Chinook salmon allocations in the buffer will not be used to harvest the pollock allocation.

The plan also includes a requirement that the Technical Representative notify the allocation management entity when the Chinook bycatch of any plan vessel reaches 95 percent of its Chinook allocation. This requirement was included in the plan to ensure that the entities managing the bycatch allocations of plan vessels have sufficient time to assess the need for and-or timing of stop fishing orders.

CP IPA Allocations and Catches for 2017

Table 1 shows the CP IPA 2017 “day-one” allocations of pollock and Chinook salmon PSC by vessel for 2017 A- and B-seasons. Table 2 shows transfers of pollock and Chinook between CP IPA vessels in 2017. Table 3 shows 2017 CP IPA pollock catch and Chinook PSC by season and vessel. Vessel bycatch performance is shown by season because the Chinook bycatch environment is different during the A-and B-seasons. During the B-season, and when fishing starts quickly, it is generally possible to complete fishing operations before Chinook salmon arrive on the shelf in the fall to feed. In other years they arrive earlier or fishing continues later, and great effort must be concentrated on limiting the bycatch.

Table 1. CP IPA Day-One Allocations of Pollock and Chinook Salmon, 2017, Including CDQ Pollock and Chinook Allocated to the CP Fleet from CDQ Partners.

| Vessel | A-season | | B-season | |
|-----------------------|--------------|-------------|--------------|-------------|
| | Pollock (mt) | Chinook (n) | Pollock (mt) | Chinook (n) |
| American Dynasty | 21,603 | 1,039 | 26,759 | 283 |
| American Triumph | 21,603 | 1,039 | 26,759 | 283 |
| Northern Eagle | 21,603 | 1,039 | 26,759 | 283 |
| Northern Jaeger | 21,603 | 1,039 | 26,759 | 283 |
| Ocean Rover | 21,603 | 1,039 | 26,759 | 282 |
| Arctic Fjord | 21,851 | 785 | 28,835 | 240 |
| Arctic Storm | 17,958 | 1,138 | 20,316 | 195 |
| Northern Hawk | 19,978 | 934 | 24,513 | 327 |
| Alaska Ocean | 25,381 | 1,309 | 31,346 | 370 |
| Pacific Glacier | 20,766 | 1,071 | 25,647 | 302 |
| Starbound | 17,287 | 946 | 26,621 | 293 |
| Island Enterprise | 13,366 | 611 | 14,805 | 149 |
| Kodiak Enterprise | 13,366 | 611 | 14,805 | 149 |
| Seattle Enterprise | 13,366 | 610 | 14,805 | 149 |
| Ocean Peace | 1,055 | 53 | 1,309 | 13 |
| Katie Ann | 0 | 0 | 0 | 0 |
| Northern Glacier | 0 | 0 | 0 | 0 |
| Total 2017 Allocation | | | 609,186* | 16,864 |
| Allocation Buffer | | | 0 | 535** |

* Total includes reallocations of pollock from the AI subarea and ICA on February 9, 17, July 11, and August 18, 2017

** Total includes an additional CDQ buffer

Table 2. Transfers of pollock and Chinook between CP IPA vessels in 2017.

| Date | From vessel | To vessel | Amount (mt or N) | Species |
|---------|--------------------|--------------------|------------------|--------------|
| 2/17/17 | Ocean Peace | American Triumph | 99 | Coop pollock |
| 2/17/17 | Ocean Peace | Northern Eagle | 99 | Coop pollock |
| 2/17/17 | Ocean Peace | Ocean Rover | 99 | Coop pollock |
| 2/17/17 | Ocean Peace | American Dynasty | 99 | Coop pollock |
| 2/17/17 | Ocean Peace | Northern Jaeger | 99 | Coop pollock |
| 2/17/17 | Ocean Peace | Alaska Ocean | 98 | Coop pollock |
| 2/17/17 | Ocean Peace | Pacific Glacier | 80 | Coop pollock |
| 2/17/17 | Ocean Peace | Island Enterprise | 65 | Coop pollock |
| 2/17/17 | Ocean Peace | Seattle Enterprise | 65 | Coop pollock |
| 2/17/17 | Ocean Peace | Kodiak Enterprise | 65 | Coop pollock |
| 2/17/17 | Ocean Peace | Arctic Storm | 53 | Coop pollock |
| 2/17/17 | Ocean Peace | Arctic Fjord | 51 | Coop pollock |
| 2/17/17 | Ocean Peace | Starbound | 45 | Coop pollock |
| 2/17/17 | Ocean Peace | Northern Hawk | 29 | Coop pollock |
| 6/2/17 | Northern Jaeger | American Triumph | 792 | Coop pollock |
| 6/2/17 | Alaska Ocean | Pacific Glacier | 662 | Coop pollock |
| 6/2/17 | Kodiak Enterprise | Island Enterprise | 443 | Coop pollock |
| 7/3/17 | Arctic Storm | Arctic Fjord | 4 | Coop pollock |
| 8/16/17 | Ocean Peace | American Dynasty | 124 | Coop pollock |
| 8/16/17 | Ocean Peace | American Triumph | 124 | Coop pollock |
| 8/16/17 | Ocean Peace | Northern Eagle | 124 | Coop pollock |
| 8/16/17 | Ocean Peace | Northern Jaeger | 124 | Coop pollock |
| 8/16/17 | Ocean Peace | Ocean Rover | 124 | Coop pollock |
| 8/16/17 | Ocean Peace | Arctic Fjord | 64 | Coop pollock |
| 8/16/17 | Ocean Peace | Arctic Storm | 66 | Coop pollock |
| 8/16/17 | Ocean Peace | Northern Hawk | 36 | Coop pollock |
| 8/16/17 | Ocean Peace | Starbound | 57 | Coop pollock |
| 8/16/17 | Ocean Peace | Alaska Ocean | 122 | Coop pollock |
| 8/16/17 | Ocean Peace | Alaska Ocean | 100 | Coop pollock |
| 8/16/17 | Ocean Peace | Island Enterprise | 80 | Coop pollock |
| 8/16/17 | Ocean Peace | Kodiak Enterprise | 81 | Coop pollock |
| 8/16/17 | Ocean Peace | Seattle Enterprise | 81 | Coop pollock |
| 8/22/17 | Kodiak Enterprise | Island Enterprise | 233 | Coop pollock |
| 8/22/17 | Pacific Glacier | Alaska Ocean | 1,229 | Coop pollock |
| 8/28/17 | Seattle Enterprise | Island Enterprise | 355 | Coop pollock |
| 9/1/17 | Pacific Glacier | Starbound | 1,050 | Coop pollock |
| 9/8/17 | American Dynasty | Northern Eagle | 1,119 | Coop pollock |
| 9/11/17 | Northern Hawk | Arctic Storm | 9 | Coop pollock |
| 3/6/17 | Northern Eagle | Arctic Fjord | 60 | CDQ pollock |
| 3/6/17 | Northern Eagle | American Dynasty | 10 | CDQ pollock |
| 3/6/17 | Northern Jaeger | Ocean Rover | 8 | CDQ pollock |
| 3/6/17 | Northern Jaeger | American Triumph | 8 | CDQ pollock |
| 3/6/17 | Northern Jaeger | American Dynasty | 2 | CDQ pollock |
| 3/7/17 | Island Enterprise | Seattle Enterprise | 10 | CDQ pollock |
| 6/2/17 | Pacific Glacier | Alaska Ocean | 9 | CDQ pollock |
| 8/28/17 | Pacific Glacier | Alaska Ocean | 3 | CDQ pollock |
| 9/18/17 | American Dynasty | Northern Jaeger | 3 | CDQ pollock |
| 9/18/17 | Northern Eagle | American Triumph | 155 | CDQ pollock |
| 9/18/17 | Northern Eagle | American Triumph | 580 | CDQ pollock |

Table 2. Continued

| | | | | |
|---------|-------------------|--------------------|-------|--------------|
| 9/18/17 | Northern Eagle | Ocean Rover | 1,263 | CDQ pollock |
| 9/18/17 | Northern Eagle | American Dynasty | 1,793 | CDQ pollock |
| 6/5/17 | Ocean Rover | American Triumph | 5 | Coop Chinook |
| 6/5/17 | American Dynasty | Northern Eagle | 11 | Coop Chinook |
| 6/5/17 | American Dynasty | American Triumph | 20 | Coop Chinook |
| 6/5/17 | American Dynasty | Ocean Rover | 23 | Coop Chinook |
| 8/16/17 | Ocean Peace | Northern Hawk | 1 | Coop Chinook |
| 8/16/17 | Ocean Peace | Arctic Fjord | 2 | Coop Chinook |
| 8/16/17 | Ocean Peace | Arctic Storm | 2 | Coop Chinook |
| 8/16/17 | Ocean Peace | Starbound | 2 | Coop Chinook |
| 8/16/17 | Ocean Peace | Seattle Enterprise | 2 | Coop Chinook |
| 8/16/17 | Ocean Peace | Kodiak Enterprise | 3 | Coop Chinook |
| 8/16/17 | Ocean Peace | Island Enterprise | 3 | Coop Chinook |
| 8/16/17 | Ocean Peace | American Triumph | 4 | Coop Chinook |
| 8/16/17 | Ocean Peace | Northern Eagle | 4 | Coop Chinook |
| 8/16/17 | Ocean Peace | American Dynasty | 4 | Coop Chinook |
| 8/16/17 | Ocean Peace | Pacific Glacier | 4 | Coop Chinook |
| 8/16/17 | Ocean Peace | Alaska Ocean | 4 | Coop Chinook |
| 8/16/17 | Ocean Peace | Ocean Rover | 5 | Coop Chinook |
| 8/16/17 | Ocean Peace | Northern Jaeger | 5 | Coop Chinook |
| 8/22/17 | Kodiak Enterprise | Island Enterprise | 148 | Coop Chinook |
| 2/27/17 | American Triumph | Northern Eagle | 2 | CDQ Chinook |
| 2/27/17 | Northern Jaeger | Ocean Rover | 8 | CDQ Chinook |
| 2/27/17 | Northern Jaeger | American Dynasty | 14 | CDQ Chinook |
| 3/6/17 | Northern Jaeger | American Triumph | 15 | CDQ Chinook |
| 3/7/17 | American Dynasty | Northern Eagle | 5 | CDQ Chinook |
| 8/28/17 | Alaska Ocean | Pacific Glacier | 101 | CDQ Chinook |

Table 3. CP IPA Pollock Catch and Chinook Bycatch Performance by Season and Vessel, 2017.

| Vessel | A-season | | | B-season | | |
|---------------------|------------------------------------|-------------|----------------------------------|--------------|---------------------------------|-------------|
| | Pollock (mt) | Chinook (n) | Rate (n/mt) | Pollock (mt) | Chinook (n) | Rate (n/mt) |
| Alaska Ocean | 21,985 | 657 | 0.029 | 34,371 | 86 | 0.002 |
| American Dynasty | 21,239 | 916 | 0.042 | 26,490 | 160 | 0.006 |
| American Triumph | 22,363 | 1,065 | 0.047 | 29,171 | 142 | 0.005 |
| Arctic Fjord | 21,879 | 728 | 0.033 | 28,909 | 217 | 0.007 |
| Arctic Storm | 17,987 | 780 | 0.043 | 20,409 | 62 | 0.003 |
| Island Enterprise | 13,861 | 588 | 0.042 | 15,607 | 144 | 0.009 |
| Kodiak Enterprise | 12,930 | 535 | 0.041 | 14,786 | 69 | 0.005 |
| Northern Eagle | 21,413 | 1,046 | 0.048 | 24,986 | 79 | 0.003 |
| Northern Hawk | 19,973 | 756 | 0.037 | 24,540 | 192 | 0.008 |
| Northern Jaeger | 20,569 | 940 | 0.045 | 27,953 | 154 | 0.005 |
| Ocean Rover | 20,802 | 1,035 | 0.049 | 27,969 | 148 | 0.005 |
| Pacific Glacier | 21,494 | 647 | 0.030 | 24,647 | 110 | 0.004 |
| Seattle Enterprise | 13,099 | 529 | 0.040 | 14,646 | 141 | 0.009 |
| Starbound | 17,282 | 794 | 0.045 | 27,709 | 159 | 0.006 |
| Northern Glacier | 0 | 0 | | 0 | 0 | |
| Katie Ann | 0 | 0 | | 0 | 0 | |
| Ocean Peace | 0 | 0 | | 0 | 0 | |
| Forum Star | 0 | 0 | | 0 | 0 | |
| American Challenger | 0 | 0 | | 0 | 0 | |
| Ocean Harvester | 0 | 0 | | 0 | 0 | |
| Neahkanie | 0 | 0 | | 0 | 0 | |
| Sea Storm | 0 | 0 | | 0 | 0 | |
| Muir Milach | 0 | 0 | | 0 | 0 | |
| Totals | 266,875 | 11,016 | 0.041 | 342,192 | 1,863 | 0.005 |
| Grand Totals | Pollock A+B (mt) 609,067 | | Chinook A+B (n) 12,879 | | Rate A+B (n/mt) 0.021 | |

Effects of Incentive Measures

This annual report provides a qualitative evaluation and some quantitative information on the effectiveness of the CP IPA in influencing vessel behavior to minimize Chinook bycatch. The CP IPA incentive program is largely an area-based program, and this evaluation relies heavily on spatial analysis of pollock trawl locations as well as the bycatch performance of the individual vessels. To begin an assessment of the IPA incentives on the individual vessels, the aggregate performance of the vessels in the 2013-2017 fisheries (recent 5 year performance) is tabulated and compared to performance during years prior to Amendment 91 regulations. Table 4 shows the aggregate bycatch performance (number of Chinook per ton of pollock caught) of CP IPA vessels 2006-2010, comprising the five years prior to

implementation of the CP IPA, and the recent five years under the IPA. It is clear from Table 4 that CP Chinook bycatch performance has greatly improved since the implementation of the IPA, as compared to previous years without incentive measures in place, although it cannot be determined what role environmental conditions and salmon abundance played throughout this time period.

Table 4. Chinook Bycatch Rates (n/mt) in the CP Fleet for 2006-2010 and 2013-2017.

| Year | A-season (n/mt) | B-season (n/mt) | A+B-season (n/mt) | A+B season (m/t) five year interval |
|------|-----------------|-----------------|-------------------|-------------------------------------|
| 2006 | 0.066 | 0.004 | 0.029 | 0.028 |
| 2007 | 0.100 | 0.017 | 0.066 | |
| 2008 | 0.027 | 0.002 | 0.012 | |
| 2009 | 0.021 | 0.002 | 0.010 | |
| 2010 | 0.024 | 0.000 | 0.009 | |
| 2013 | 0.018 | 0.001 | 0.008 | 0.013 |
| 2014 | 0.020 | 0.002 | 0.009 | |
| 2015 | 0.016 | 0.007 | 0.011 | |
| 2016 | 0.032 | 0.007 | 0.017 | |
| 2017 | 0.041 | 0.005 | 0.021 | |

Figure 3 shows the range of vessel bycatch performance each year since 2003, during the time period when Chinook are most abundant on the pollock fishing grounds (September-February). In the prior program, the bycatch performance of a pollock cooperative (group of vessels) was evaluated against a performance benchmark, and under some circumstances, incentives to avoid bycatch weakened for an individual vessel. However, if incentive measures are working at the vessel level, one would expect the distribution of Chinook bycatch rates among the vessels to shrink. This is because vessels are accountable for their own Chinook bycatch, and better performers cannot shelter less well performing vessels. Evident from this graph is that, since the IPA began, vessel bycatch rates have been among the lowest on record, and also that the variance of rates among vessels is reduced (has been very small) in the IPA years, even relative to previous years with similar average rates. **In other words, Chinook bycatch rates among vessels display a smaller range of values since 2011 than in previous years, providing evidence of the effectiveness of the vessel-level incentives.**

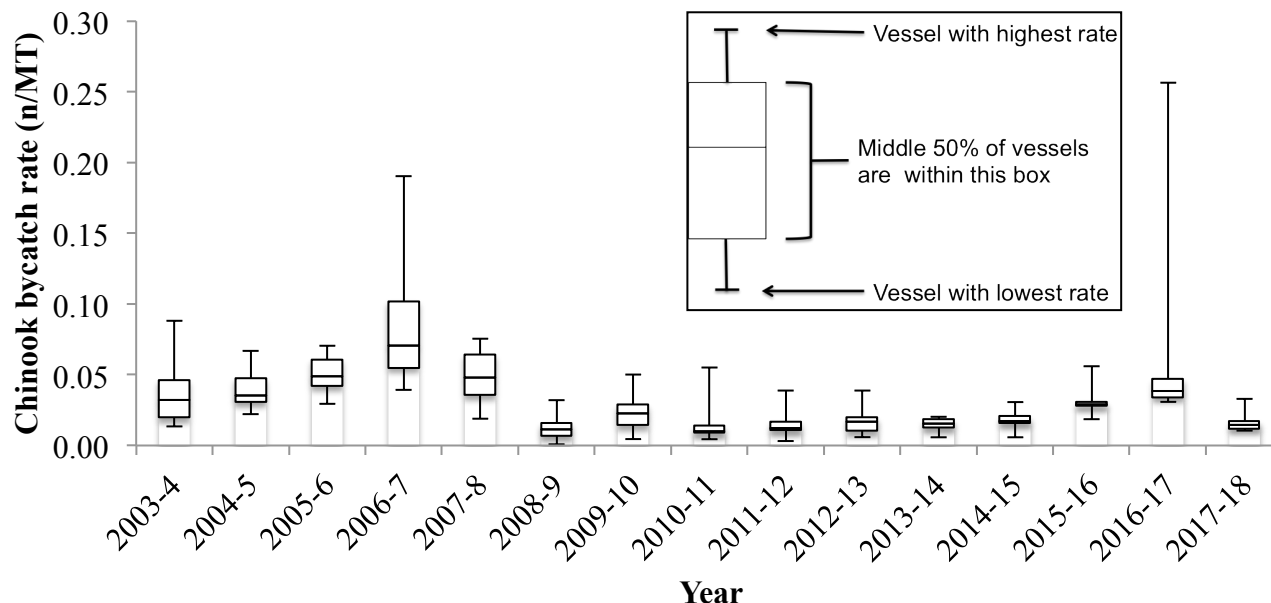

Figure 3. September-February CP Vessel Chinook Bycatch Rate Distribution by year 2003-2018.

Another way to look at how incentives have been working at the individual vessel level is to compare the frequency of different levels of Chinook bycatch rates by individual vessels in the period before and after the implementation of Amendment 91. A narrowing distribution of vessel performance in the period since Amendment 91 indicates that vessels are behaving more similarly to each other, thus are exhibiting vessel-level accountability for their Chinook bycatch. Figure 4 shows the distribution of vessel bycatch rates in the A-seasons of 2009-2010 (pre-Amendment 91; top panel) and the same distribution in the A-seasons of 2016-2017 (post-Amendment 91; bottom panel). This figure shows a much higher overall average Chinook bycatch rate in the more recent period due to a noticeable increase in Chinook on the fishing grounds, particularly in 2017, but a sharp narrowing of the distribution of vessel performance around this mean, thus demonstrating more vessel-level accountability in the period since Amendment 91 implementation. Figure 5 shows the same information for the 2017 A-season only and a clear shift of the distribution to the left in the absence of incentives.

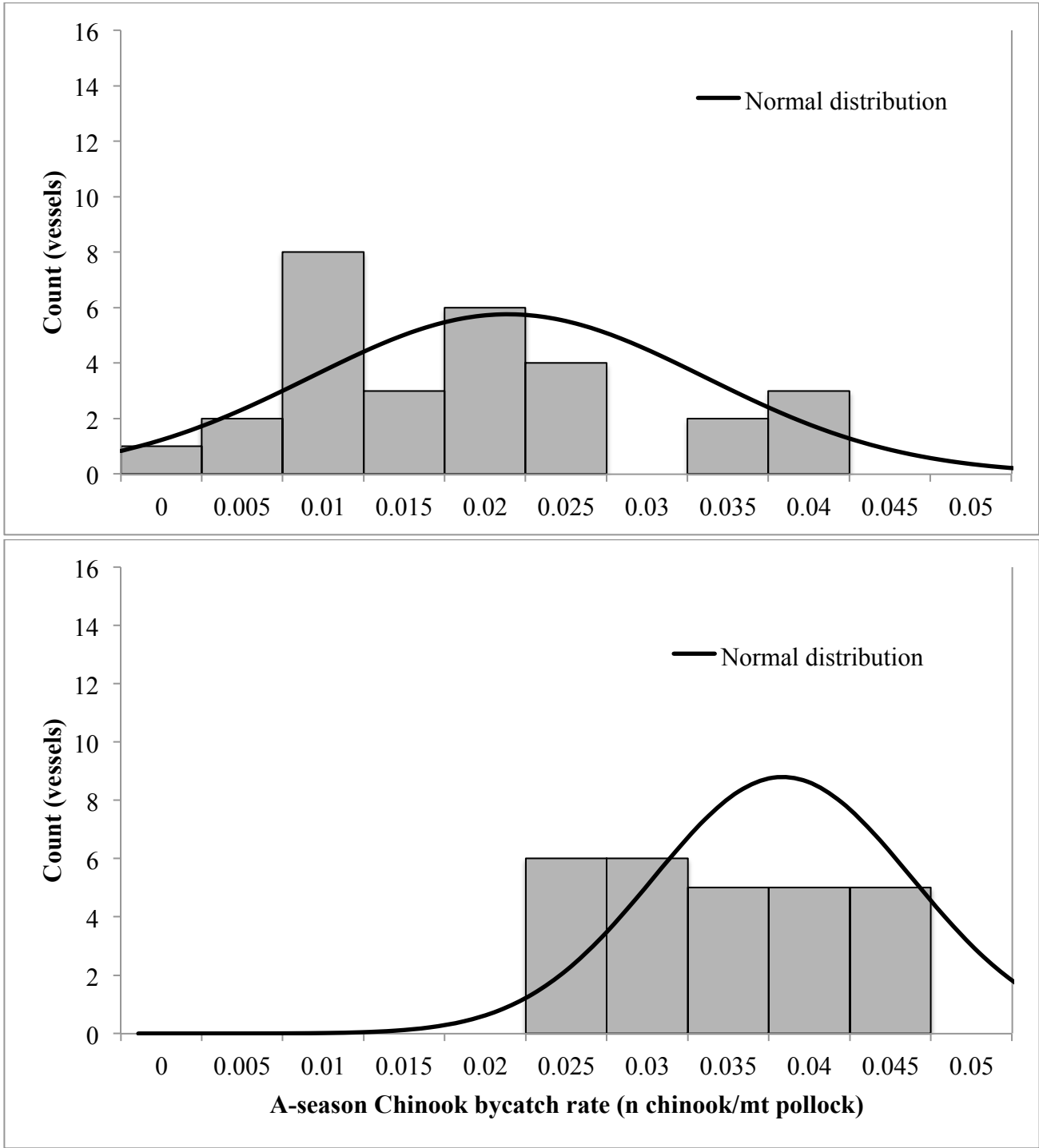

Figure 4. A-Season CP Vessel Chinook Bycatch Rate Distribution for 2009-2010 (top) with variance of 0.011 and 2016-2017 (bottom) with variance of 0.007.

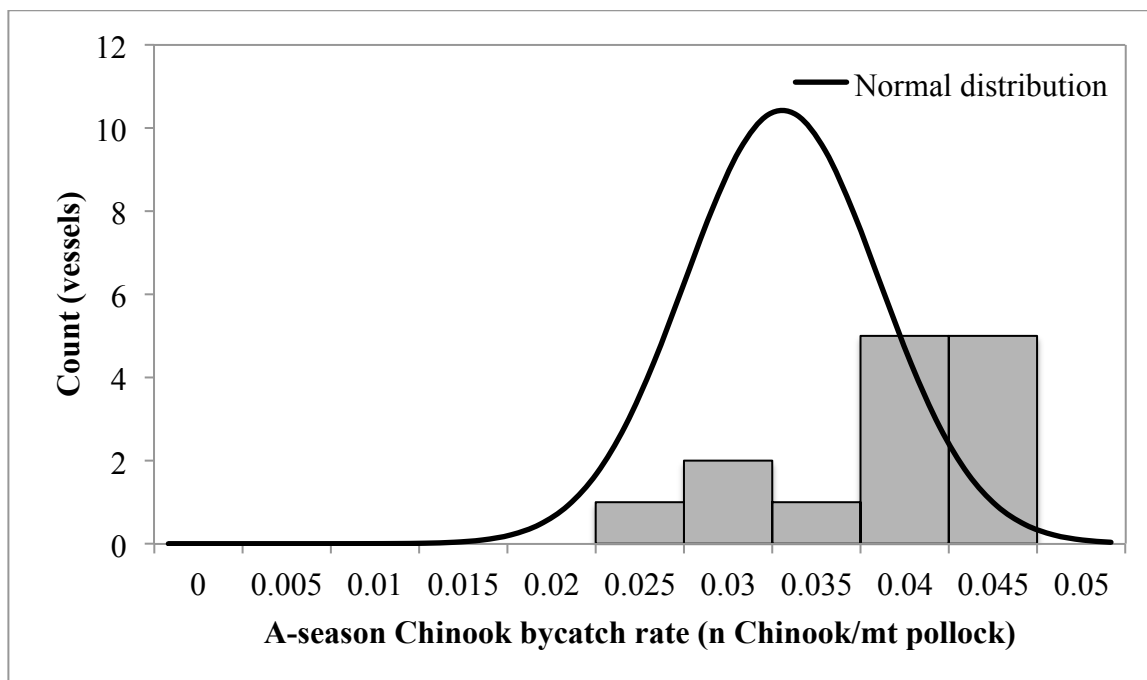

Figure 5. A-Season CP Vessel Chinook Bycatch Rate Frequency Distribution for 2017.

The incentive to avoid chronic vessel poor bycatch performance first came into force during 2015, but its provisions applied retroactively to vessel performance during the 2014 A- and B-seasons. During the past eight seasons, seven unique vessels have been designated an “outlier” for their Chinook bycatch performance, with three vessels a repeat poor performer not in consecutive seasons.

Figure 6 below shows the relative performance of the fleet for the 2017 A- and B-seasons. Differences are evident between vessel bycatch performance in A-season versus the B-season, therefore the provision is applied on a seasonal basis to account for different bycatch environments. The maximum number of vessels that can fall in the worst 10% of fleet performance is three with a minimum of one vessel. However, due to the extremely narrow distribution of bycatch rates in the 2017 A-season, and competition to avoid being the outlier vessel, there were no statistically poor performing vessels. During the 2017 B-season there were two vessels that separated themselves from the otherwise narrow distribution shown above during the 2017 B-season. The outlier vessels shown above averaged less than one Chinook per 100 tons of pollock catch. The new disincentive to chronic poor bycatch performance has proven effective in its first four years of implementation—only three vessels have been repeat outliers in the past eight seasons and no vessels have been outliers in consecutive seasons. Vessels now have strong incentive to change fishing behavior to avoid being an outlier in any consecutive seasons, because although a vessel might have long periods of good relative bycatch performance, one lightning strike trawl can render it an outlier in any given season. Given a constant abundance of Chinook and pollock over time, the incentive provision should encourage a shift in the distribution of vessel bycatch performance to the left.

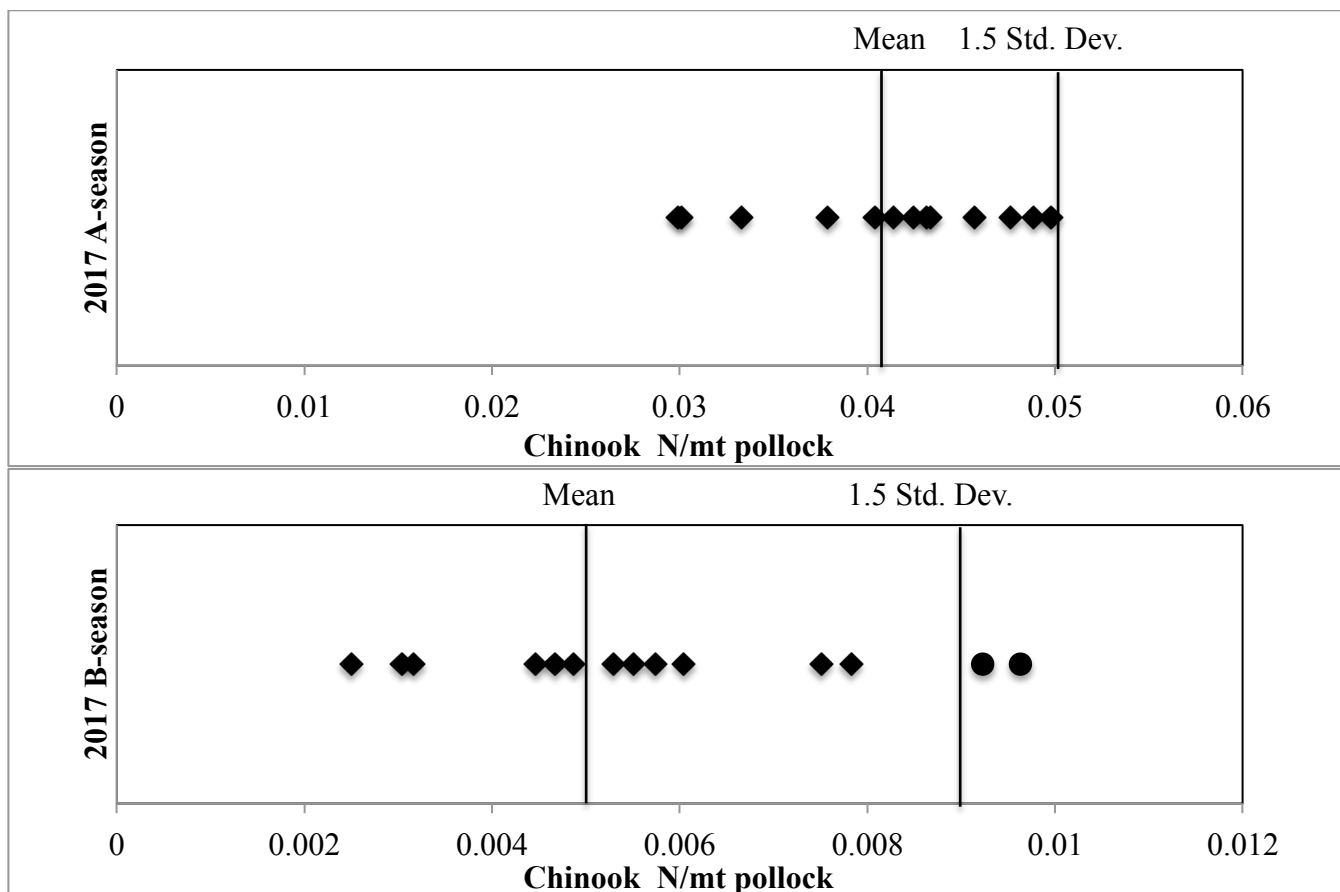

Figure 6. Fleetwide Chinook bycatch ratio distribution for 2017 fishing seasons. Circles denote outlier vessels.

Chinook Bycatch Avoidance Behavior

As mentioned previously, important elements of the CP IPA incentive program include: 1) the provision of real-time information to the fleet concerning areas of relatively high Chinook salmon abundance; and 2) designated time-area closures for vessels with Chinook bycatch rates higher than 75% of the base rate. Over time, data on Chinook bycatch rates on the fishing grounds has revealed certain patterns, with the highest bycatch rates occurring in predictable areas at certain times of the year. Figure 7 shows all CP fishing locations between 2000 and 2017 during the time period where Chinook are most often present on the EBS shelf (September-February), color coded according to Chinook bycatch rate. The blue crosses indicate trawls made between 2000 and 2010—the years prior to Amendment 91. The orange crosses indicate tows taken between 2011 and 2017—the years since Amendment 91. It is clear from this figure that CP pollock vessels are now avoiding grounds with the highest Chinook bycatch rates (darkest blue) historically. The presence of blue crosses in these areas means these are productive pollock fishing grounds, and the absence of orange crosses indicates these areas are now being avoided in order to avoid Chinook.

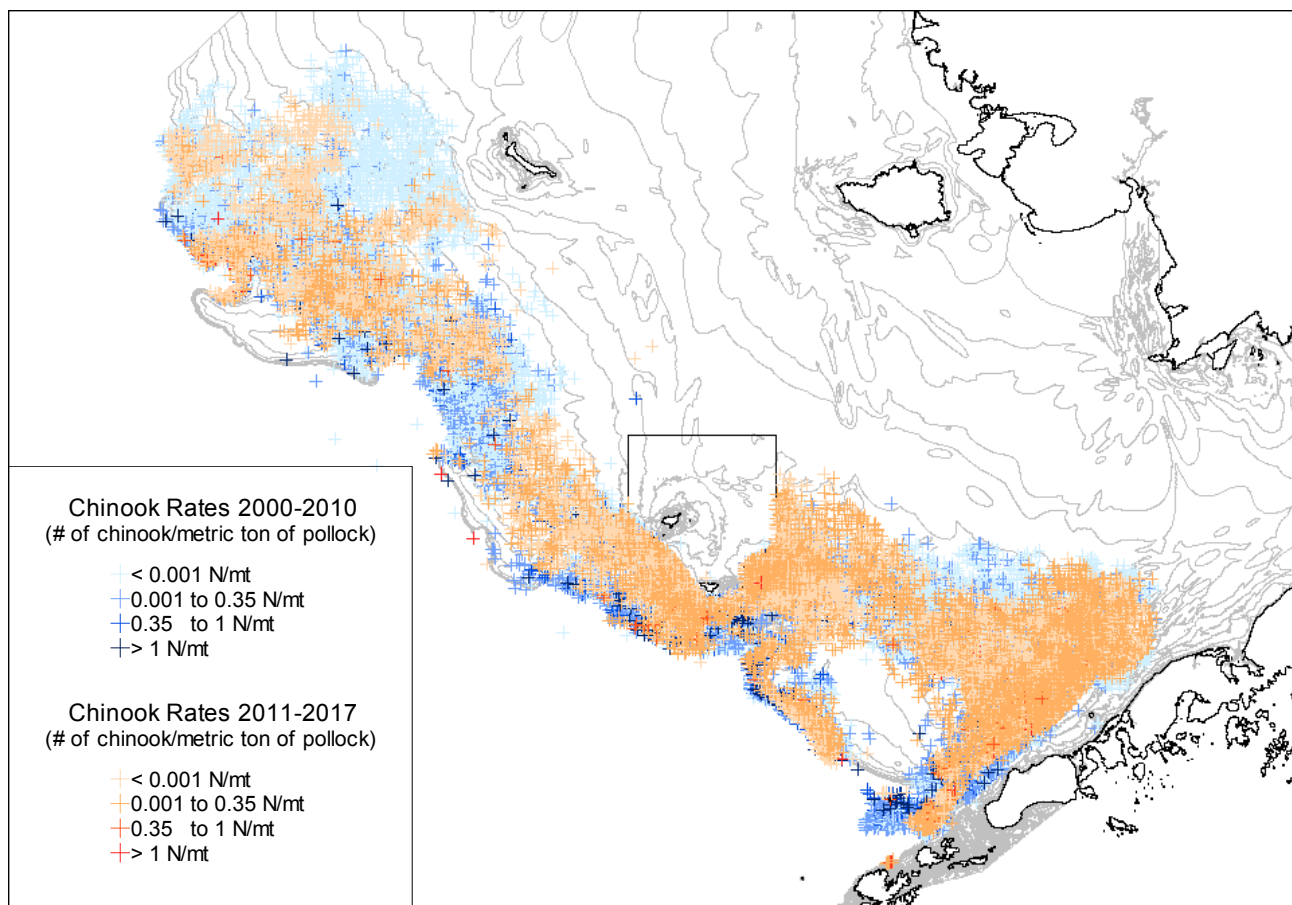

Figure 7. Pollock CP trawl locations between September 1st and February 28th for the years 2000-2010 (blue), 2011-2017 (orange). Darker color indicates higher Chinook bycatch rates.

A close examination of the trawl locations in space and time, their bycatch rates, and the bycatch performance of all CP IPA vessels shows clearly that the vessels have changed their fishing strategy to avoid Chinook bycatch. The most salient feature of this changed approach was for vessels to locate initial fishing operations away from the outer margins of the shelf. Depending on the locations of pollock concentrations, any profitable movement of fishing to deeper water has been accomplished via a deliberate, slow, and cautious progression while maintaining awareness of information about Chinook concentrations within the area. Evidence of local Chinook concentrations generally caused vessels fishing in deep water to move fishing to more shallow grounds. This behavior was most pronounced during the A-season and occurred in multiple areas when trawl bycatch rates showed high concentrations of salmon, as e.g., when schools of Chinook salmon move into a local area to feed.

As mentioned in the above paragraph, an important component of changing CP fishing behavior subsequent to Amendment 91 is fishing depth, because Chinook salmon are known to occur in deeper areas along the EBS shelf. Comparing effort, pollock and Chinook catches in the five years prior to and five years since Amendment 91, there has been a clear reduction in the amount of fishing effort at depths greater than 130 fathoms, where a large portion of Chinook bycatch has typically been encountered. In recent years, most A-season fishing has occurred at depths less than 50 fathoms and roe recovery has been significantly reduced as the target fish size and age typically declines in shallower waters.

Under the RHS program, several BAA were designated for the CP fleet during the 2017 A-season (Figure 8). The BAA are made known to all vessels on a weekly basis; only those vessels with a Chinook bycatch rate of greater than 75% of the base rate are required to avoid these areas. However, because the designations indicate where Chinook bycatch has been highest over a given week, even vessels that are not required to fish outside the BAA often voluntarily do so, in order to avoid Chinook bycatch. It is important to remember that, due to the way the base rate is calculated, there must be pollock fishing in an area in order for it to become a bycatch avoidance area, so those areas where CPs avoided fishing entirely will not contain any BAA.

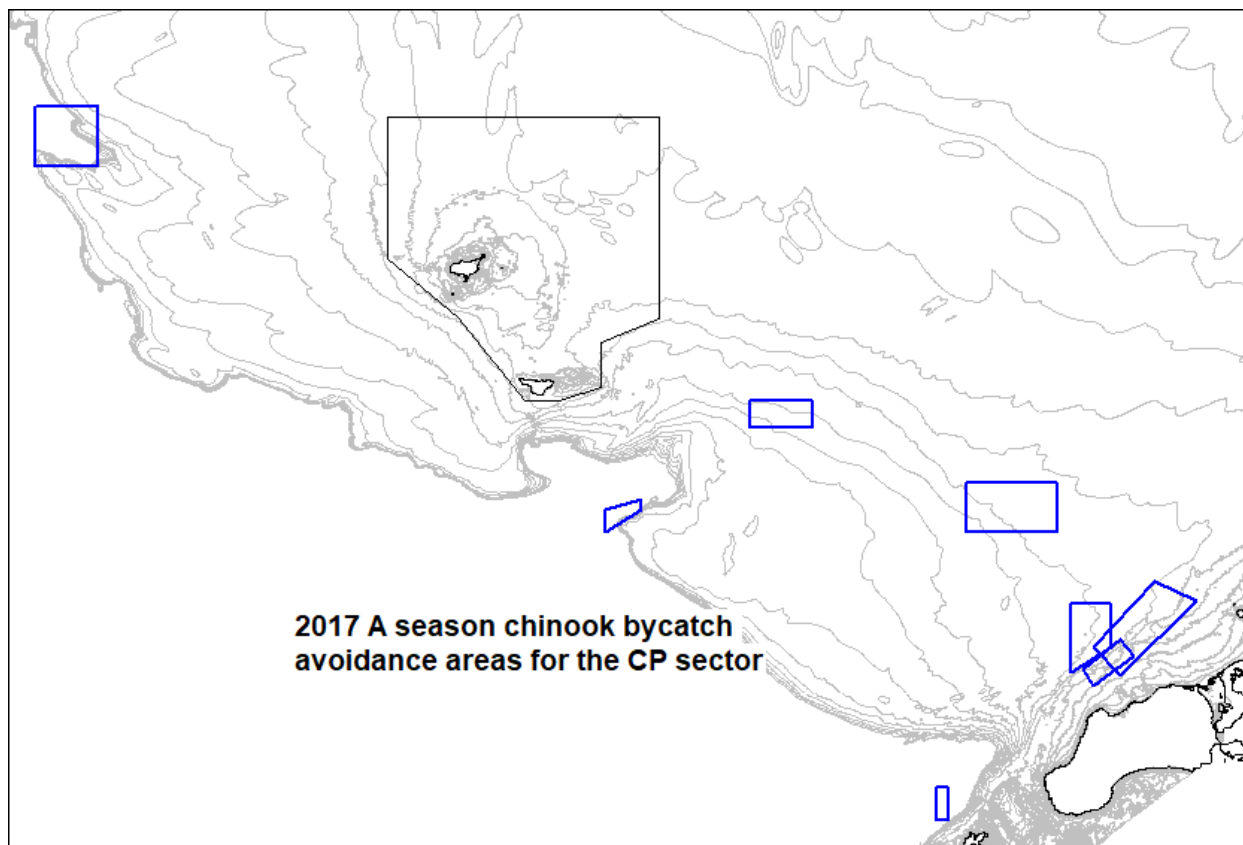

Figure 8. Chinook bycatch avoidance areas for the CP sector, A-season, 2017.

Table 5 shows the A-season weeks of 2017 and the number of vessels excluded from designated bycatch avoidance areas for Chinook salmon during each week. There were a total of fourteen CP BAA during the 2017 A-season and 4 CP BAA for the B-season, with 2 vessels prohibited from fishing in B-season BAA. There was also one vessel subject to an extended (2-week) fishing prohibition during 2017.

Table 5. Number of CP vessels excluded from designated Chinook bycatch avoidance areas during the 2017 A-season.

| Week | 1/27 | 2/03 | 2/10 | 2/17 | 2/24 | 3/03 | 3/10 | 3/17 | 3/24 | 3/31 | 4/07 |
|----------------------------------|------|------|------|------|------|------|------|------|------|------|------|
| Number of CPs excluded from BAAs | 10 | 11 | 7 | 12 | 12 | 9 | 11 | 12 | 10 | 10 | 1 |

Chum Salmon Bycatch Avoidance Behavior

Estimates of the stream-of-origin of chum salmon bycatch show bycatch of western Alaska chum salmon to be most prevalent in NMFS statistical area 509 and least prevalent in area 521. Analyses also indicate that chum salmon from western Alaska make up the greatest proportion of bycatch in the pollock fishery from early June to mid August. The combined-size limits of chum salmon BAA are largest East of 168 degrees West longitude during the months of June and July to match this pattern of chum salmon abundance. In addition, the base-rate “floor” is lowest during June and July. Both of these program components are estimated to increase the size of candidate BAA when and where chum salmon that are likely to return to western Alaska rivers are encountered. The figure below shows that thousands of square miles in the fishable areas of the Bering Sea East of 168 degrees West longitude, were closed to pollock fishing by CP IPA vessels during June, July and August of 2017.

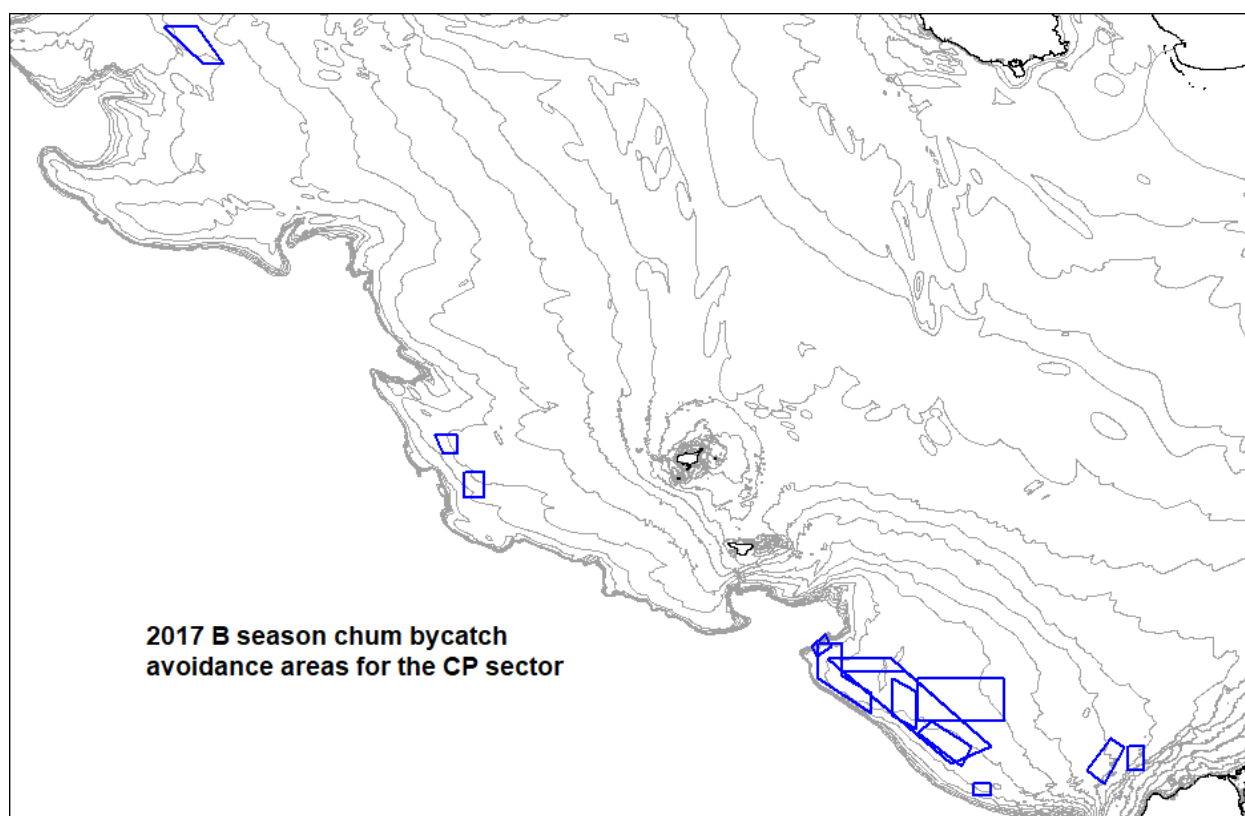

Figure 9. Chum bycatch avoidance areas for the CP sector during June, July and August, 2017.

Table 6 shows the B-season weeks of 2017 and the number of vessels excluded from designated bycatch avoidance areas for chum salmon during each week. There were a total of thirteen CP BAA for the B-season. From July 14th through August 4th, all CP IPA vessels were restricted from fishing within the Bycatch Avoidance Areas that were identified, which caused significant movement by the fleet and lost fishing time.

Table 6. Number of CP vessels excluded from chum salmon designated bycatch avoidance areas during the 2017 B-season.

| Week | 6/30 | 7/7 | 7/14 | 7/21 | 7/28 | 8/04 | 8/11 | 8/18 | 9/01 | 9/08 | 9/15 |
|----------------------------------|------|-----|------|------|------|------|------|------|------|------|------|
| Number of CPs excluded from BAAs | 0 | 5 | 13 | 14 | 14 | 11 | 8 | 2 | 1 | 1 | 5 |

Chinook PSC Rates in October

All CP IPA vessels completed B-season fishing operations by the end of September 2017, thus incentives to control spiking Chinook PSC rates in October were not applicable. Amendment 110 regulations shifting 5% of the pollock allocation from the B-season to the A-season can be credited with this early conclusion to the 2017 fishery.

Ongoing Gear Research and Development

In accordance with the Amendment 110 regulations, the CP IPA requires all vessels use a salmon excluder device during trawls made during the A-season and the end of the B-season. During 2017, vessel crew and Pollock Conservation Cooperative staff continued an at-sea monitoring program to evaluate the design and rigging of the salmon-excluder trawls used by IPA vessels. Monitoring is accomplished using deploy-and-retrieve video cameras placed in the trawl net.

Continued use of a prototype titanium trawl camera from MacMarine Incorporated (MMI) was conducted aboard CP IPA vessels during the pollock fishery in 2017. The camera incorporates a 4-LED array and a Mobius ActionCam HD wide-angle lens camera and DVR combination. In addition, new flapper materials, weighting of flapper panels, and monitoring of escape openings have been conducted aboard PCC vessels.

Great progress has been made in the development of and use of salmon lights to assist in attracting salmon to escape routes in the salmon excluder. PCC staff worked together with KAMI Tech and the Sexton Corporation to design and fabricate LED salmon lights. PCC companies purchased a large batch of salmon lights with both red and blue light wavelengths and two variations of base plating for mounting within the trawl at two locations. Additionally, charging stations were designed and installed on PCC vessels with delivery of the salmon lights occurring in time for the 2018 A-season fishing operations. Pictured below is a prototype design from the Sexton Corporation mounted to a base plate.

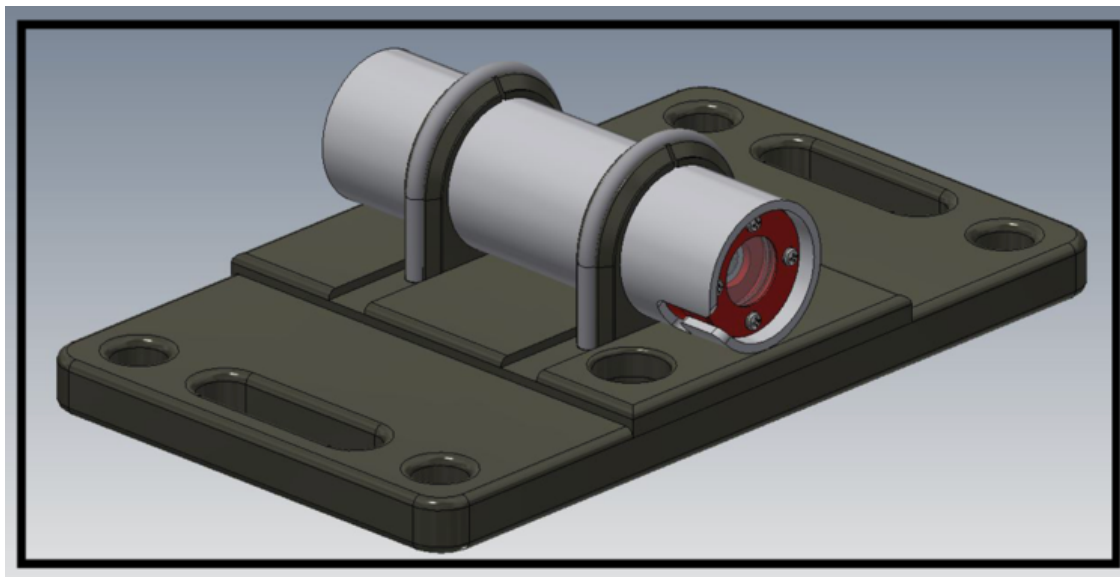

Results from ongoing experimental trials continue to indicate that salmon bycatch is highly variable trawl-to-trawl even for circumstances where trawls are spaced very closely in space and time. Similarly, the experiments so far conducted indicate the salmon escape fractions are as variable, if not more so, than salmon bycatch, trawl-to-trawl, even for circumstances where trawls are spaced very closely in space and time. The goal of future experiments is to develop new gear technologies that produce escape fractions that would be more consistent and higher than those obtained currently.