



UNITED STATES DEPARTMENT OF COMMERCE
National Oceanic and Atmospheric Administration

National Marine Fisheries Service

P.O. Box 21668

Juneau, Alaska 99802-1668

AGENDA B-3

APRIL 2000

Supplemental

March 30, 2000

RECEIVED

APR - 6 2000

N.P.F.M.C

Mr. Richard B. Lauber
Chairman, North Pacific Fishery
Management Council
605 W. 4th Avenue, Suite 306
Anchorage, Alaska 99501-2252

Dear Rick,

Bycatch rate standards for trawl fisheries under the Pacific halibut and red king crab vessel incentive program during the second half of 2000 are scheduled to be published in the Federal Register by July 1, 2000. A summary of 1996 - 2000 observer data on fishery bycatch rates is listed in the attached table for review by the Council. The halibut bycatch rates for the four quarters of 1999 have been updated and the first quarter of 2000 added. In the Bering Sea & Aleutian Islands midwater pollock fishery, the first quarter halibut bycatch rate in the Bering Sea fishery has moderated in 2000 vs 1999. The higher first quarter rates in the yellowfin sole fishery for halibut and red king crab in zone 1 may reflect the limited duration of the active fishery during the last week of March.

Unless the Council recommends a change in these standards, we will use for the second half of 2000 the halibut and red king crab bycatch rate standards listed in the attached table for the third and fourth calendar quarters of the year.

Sincerely,

Steven Pennoyer
Administrator, Alaska Region

Attachment



1996 - 2000 (through March 27, 2000) observed bycatch rates, by quarter, of halibut and red king crab in the fishery categories included in the vessel incentive program. Also listed are the bycatch rate standards established since 1995.

Halibut Bycatch (Kilograms Halibut/metric ton Allocated Groundfish Catch)

<u>Fishery and quarter</u>	<u>Bycatch Rate Standards</u>	<u>1996</u>	<u>1997</u>	<u>1998</u>	<u>1999</u>	<u>2000</u>
BSAI Midwater Pollock						
QT 1	1	0.1	0.1	0.02	0.15	0.04
QT 2	1	0.02	0.4	0.00	-	
QT 3	1	0.09	0.1	0.33	0.06	
QT 4	1	0.21	0.1	0.25	0.04	
BSAI Bottom Pollock						
QT 1	7.5	2.22	1.4	9.09	1.29	0.20
QT 2	5	12.84	0.0	0.01	-	
QT 3	5	0.41	1.4	6.70	3.87	
QT 4	5	0.64	0.4	1.47	0.13	
BSAI Yellowfin sole						
QT 1	5	2.89	6.5	9.65	4.21	6.35
QT 2	5	4.19	5.1	6.48	7.30	
QT 3	5	6.86	2.6	7.30	18.59	
QT 4	5	12.41	4.1	13.71	24.26	
BSAI Other Trawl Fisheries						
QT 1	30	10.66	8.9	12.05	14.54	8.29
QT 2	30	12.71	10.3	13.98	24.83	
QT 3	30	6.37	21.2	11.60	6.12	
QT 4	30	34.24	3.1	11.54	8.71	
GOA Midwater Pollock						
QT 1	1	0.26	0.0	0.18	0.31	0.03
QT 2	1	0.04	0.1	0.14	0.23	
QT 3	1	0.03	0.1	0.04	0.12	
QT 4	1	0.47		0.03	0.03	
GOA Other Trawl Fisheries						
QT 1	40	14.65	0.18	26.23	32.48	23.15
QT 2	40	49.01	62.4	58.88	58.87	
QT 3	40	24.71	26.0	37.98	18.14	
QT 4	40	46.9	47.9	58.20	69.04	
Zone 1 Red King Crab Bycatch Rates (number of crab/mt of allocated groundfish)						
BSAI Yellowfin sole						
QT 1	2.5	0	0.1	0.01	0.09	
QT 2	2.5	0.01	0.1	0.03	0.01	
QT 3	2.5	0		0.43	1.08	
QT 4	2.5	0		0.15	0.25	
BSAI Other Trawl Fisheries						
QT 1	2.5	0.14	0.1	0.04	1.38	1.24
QT 2	2.5	0	0.0	0.06	0.20	
QT 3	2.5	0.08	0.0	0.25	0.00	
QT 4	2.5	0	0.0	0.02	0.00	

FMP Amendment status since February 1999	DATE OF COUNCIL ACTION	Start Regional Review	Submitted to NMFS Headquarters	Notice of FMP amendment published	PR Published in FEDERAL REGISTER	FR Published in FEDERAL REGISTER
Amendment 57 BSAI - Bottom trawl ban for pollock - final rule Approved by NMFS 2/24/00	Jun-98	3/17/2000	4/3/2000	12-10-99 64 FR 69219 EOC 2/8/00	12-29-99 64 FR 73003	
Amendment 59 GOA - Prohibit fishing on Cape Edgecomb pinnacles	Jun-98	12/3/1999				
Amendment 54/54: Allow indirect vessel ownership in the IFQ hired skipper provisions; add language specific to estates in the definition of a "change" in a corporation or partnership; and change the sablefish use caps to be expressed in numbers of QS units, rather than as a percentage of the QS pool.	Oct-98	10/1/1999				
Amendment 60/58/10 - LLP	Oct-98	7/28/1999				
Amendment 4 PR - Scallop LLP	Feb-99	10/8/1999	2/29/2000	3/9/00 65 FR 12500 EOC 5/8/00		
Final rule for Amendment 58 (BSAI) Chinook salmon bycatch control NMFS Approval of Amendment on 2-2-00	Feb-99	3/3/2000		11/4/1999 64 FR 68157	12-21-99 64 FR 71390 EOC	
Amendment 6 - Salmon Overfishing	Feb-99	3/30/1999	Staff working to define MSST			
Amendment 66 (BS) - Remove squid from CDQ	Jun-99	8/15/1999				
Amendment 61/61 Management of co-ops and sideboards	Jun-99					
Amendment 11 - Bairdi rebuilding plan	Oct-99	12/7/1999	2/25/2000	3/7/00 65 FR 11973 EOC 5/8/00 Will be published 4-11-00	No rulemaking for this action	
Amendment 64 - BSAI Fixed gear cod allocations	Oct-99	11/26/1999	3/27/2000			
Amendment 48/48 Specification streamlining	Apr-98	6/2/1998	Discussion paper on revised 48/48 to Council April 2000			

Regulatory Amendment Action Staff work ongoing or initiated since February 2000	DATE OF COUNCIL ACTION	Start Regional Review	Submitted to NMFS Headquarters		PR Published in FEDERAL REGISTER	FR Published in FEDERAL REGISTER
Regulatory Amendment - Atka mackerel VMS Proposed rule	Jun-98	5/19/1999	2/29/2000			
Chiniak trawl closure	Feb-00	3/30/2000				
Steller sea lion conservation measures - proposed rule	Jun-99					
Scale performance criteria Final Rule	NMFS	1/10/2000			12-2-99 64 FR 67555 EOC 1/3/00 12/27/99	
IFQ cost recovery plan Final Rule	NMFS	2/1/2000	2/23/2000		64 FR 72301 EOC 1/26/99	3/20/00 65 FR 14919 Effective 3/15/00
2000 GOA Final Harvest Specifications	Dec-99	1/20/2000	2/7/2000		12-28-99 64 FR 72572	2/15/00 65 FR 8298
2000 BSAI Final Specifications	Dec-99	1/20/2000	2/7/2000		12-13-99 64 FR 69464	2/18/00 65 FR 8282
2000 Pacific Halibut Management Measures	Jan-00 IPHC/NMFS					3/20/00 65 FR 14909
Reduction in CDQ shoreside observer coverage	NMFS		3/6/2000			
Corrections to LLP Transfer provisions - final rule	NMFS		4/5/2000			
IFQ Omnibus 3 PR	NMFS	5/20/1998				
Revise definition of vessel length overall	NMFS					
2000 Recordkeeping & Reporting	Jun-99					
Crab CDQ season start date	Oct-98					
Technical amendments to LLP	NMFS					
Commercial Operator's Annual Report PR	Jun-99	9/16/1999				

Analyses or regulatory actions tasked to NMFS staff but not yet initiated due to other work priorities	DATE OF COUNCIL ACTION	START REGIONAL REVIEW	SUBMITTED TO DOC		PR PUBLISHED IN FEDERAL REGISTER	FR PUBLISHED IN FEDERAL REGISTER
Extend halibut donation prog. - expires 12/31/00						
Regulatory Amendment - Revise IR/IU	Feb-99					
DSR - full retention/donation	Jun-99					
HMAP						
Halibut 4D/4E issues trip limits, location of catch						
Revise timing of motions of reconsideration of appeals	NMFS					
Buyback program: Crab						
Regulatory Amendment - Establish the IFQ Loan Program						
Product Recovery Rates - revision - PR						
CDQ cost recovery plan	NMFS					
OTHER ONGOING OR UPCOMING STAFF WORKLOAD PRIORITIES						
<p>Opilio and St. Matthews rebuilding plan -- development Groundfish SEIS - staff work EIS development on specific management actions Ongoing ESA analyses Revisions to AFA regulations Observer program analyses and regulations Analyses (new and ongoing) associated with the MSCDQ program Charter Boat GHJ Experimental Fishing permits (two applications submitted to NMFS for 2000)</p>						

**North
Pacific
Longline
Association**

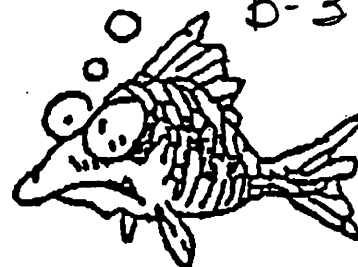

Agenda B - NMFS Mgt.

April 4, 2000

Mr. Richard B. Lauber, Chairman
North Pacific Fishery Management Council
605 West 4th Avenue
Anchorage, AK

RE: Transfer of Halibut PSC

Dear Rick:

Because of the short "A" season in the BSAI fixed gear cod fishery this year, the freezer-longliner fleet used 111 mt less halibut than during the 1999 "A" season (157 mt v. 268 mt). We anticipate that the remaining halibut PSC for the "C" season cod fishery is far in excess of our needs. For that reason we would like to transfer 100 mt of halibut PSC from BSAI cod to BSAI turbot for FY 2000. NMFS advises this can easily be done with Council approval.

We calculate that there would be some 490 mt of halibut PSC left for the cod fishery after the transfer. This is far in excess of the halibut needed to harvest the available cod. The transfer should help us to Achieve OY in the turbot fishery.

Thank you for your attention to this matter.

Sincerely,

Thorn Smith

Attachments

BERING SEA TURBOT FISHERY SUMMARY

W/Ending	2000	1999	1998	1997	1996
Turbot Allocation and Actual Catch					
Quota - Turbot					
TAC	6,030	6,030	10,050	6,030	4,667
ITAC	5,126	5,126	8,543	5,125	3,967
CDQ	452	452	754	0	0
Open Access	5,126	5,126	8,543	5,125	3,967

Note: Reserve (TAC - ITAC) generally reserved for trawl/other bycatch

Catch - Turbot					
Longline	3	3,499	6,174	4,672	3,977
Trawl	41	1,644	1,753	982	848
Pot	0	25	4	0	2
Total	44	5,168	7,931	5,654	4,827

Actual Halibut Bycatch

Halibut - Other (Open Access)					
"A"		63	61	53	94
"B"		13	0	0	0
Total		76	61	53	94

Halibut - Cod (Open Access)					
Allocation	766	598	777	840	800
"A"	157	268	264	253	383
"B"		0	37	83	44
"C"		144	451	501	361
Total		412	752	837	788

Halibut Bycatch Allocations

Cod Halibut Allocation	810	810	840	840	800
CDQ	61	61	63	0	0
"A"	457	457	458	495	475
"B"	0	0	37	40	40
"C"	291	291	282	305	285
Total (Open Access)	748	748	777	840	800
Transfer to Turbot		(150)	0	0	0
Total		598	777	840	800

Turbot Halibut Allocation

Turbot Halibut Allocation					
Turbot					
CDQ	7	7	4	0	0
"A"	83	41.5	56	60	100
"B"	0	41.5	0	0	0
Total Allocation	90	90	60	60	100
Transfer from Cod	100	150	0	0	0
Total	190	240	60	60	100

Turbot Halibut Mortality	19%	19%	12%	11%	
---------------------------------	------------	------------	------------	------------	--

2000 BSAI Trawl Fisheries PSC Council Recommended Apportionments and Seasonal Allowances DRAFT

Fishery Group	Halibut Mortality Cap (mt)	Herring (mt)	Red King Crab (animals) Zone1	C. bairdi Zone1	C. bairdi Zone2	C. opilio COBLZ
Yellowfin sole	26.06% 958	9.14% 169	12.99% 12,600	37.61% 312,163	64.98% 1,637,448	71.49% 3,109,815
January 20 - March 31	29.63%					
April 1 - May 20*	22.00%					
May 21 - July 3	5.45%					
July 4 - Dec 31	42.82%					
Rocksole/other flatfish	22.91% 842	1.31% 24	72.17% 78,005	40.29% 334,487	21.66% 545,832	21.62% 940,470
January 20 - March 31	57.62%					
April 1 - July 3	20.95%					
July 4 - December 31	21.31%					
Turbot/sablefish/ Arrowtooth		0.59% 11				1.02% 44,370
Rockfish	2.03% 75	0.47% 9			0.42% 18,884	1.02% 44,370
July 4 - Dec 31						
Pacific cod	42.18% 1,550	1.31% 24	12.99% 12,600	20.17% 167,411	11.83% 298,116	3.07% 133,545
Pollock/mackerel/o.species	6.82% 250	87.18% 1,616	1.85% 1,795	1.93% 16,819	1.10% 27,720	1.78% 77,430
TOTAL	3,675	1,853	97,000	830,000	2,520,000	4,350,000

- 1) Includes 7.5% CDQ allocation.
- 2) Unused PSC allowances may be rolled into the following seasonal apportionment.
- 3) 35% of the red king crab PSC for the rock sole fishery is apportioned to the 56 - 56 o10' RKCSA strip.
- 4) Accounts for the reductions in halibut and crab PSCs due to ban on pollock bottom trawling
(halibut: -100 mt; RKC: -3,000; Z1 bairdi: -20,000; Z2 bairdi: -30,000; opilio: -150,000 crab)
- 5) Accounts for adjustments due to changes in biomass for herring, red king crab, Z2 bairdi, and opilio.
- 6) For herring PSC in pollock/mackerel/o.species category, 1,558 mt for midwater pollock fishery.

2000 BSAI Non-Trawl Fisheries PSC Bycatch Allowances and fixed gear Pacific cod seasonal apportionments

Fishery Group	Halibut Mortality (mt)	Seasonal Apportion of cod TAC (mt)
Pacific Cod	810	
Jan 1 - April 30	495	65,000 first tr.
May 1 - August 31	0	0 second tr.
Sept. 1 - Dec. 31	315	26,048 third tr.
Other Non-Trawl*	90	
May 1 - December 31	90	
Groundfish Pot	Exempt	
TOTAL	900 mt	91,048

Note: unused halibut PSC or P. cod TAC from first trimester will be rolled into the third trimester.
Any halibut PSC removed from the CDQ fisheries will be replaced from PSC apportioned from the third trimester.

- * Includes hook & line fisheries for rockfish and Greenland turbot.
Sablefish hook & line fisheries will be exempted from the halibut mortality cap.
Rig gear will also be exempted from the halibut mortality cap.

**North
Pacific
Longline
Association**

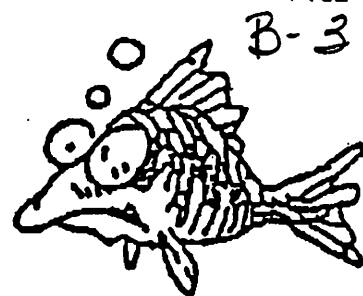

Agenda B - NMFS Mgt.

April 4, 2000

**Mr. Richard B. Lauber, Chairman
North Pacific Fishery Management Council
605 West 4th Avenue
Anchorage, AK**

RE: Transfer of Halibut PSC

Dear Rick:

Because of the short "A" season in the BSAI fixed gear cod fishery this year, the freezer-longliner fleet used 111 mt less halibut than during the 1999 "A" season (157 mt v. 268 mt). We anticipate that the remaining halibut PSC for the "C" season cod fishery is far in excess of our needs. For that reason we would like to transfer 100 mt of halibut PSC from BSAI cod to BSAI turbot for FY 2000. NMFS advises this can easily be done with Council approval.

We calculate that there would be some 490 mt of halibut PSC left for the cod fishery after the transfer. This is far in excess of the halibut needed to harvest the available cod. The transfer should help us to Achieve OY in the turbot fishery.

Thank you for your attention to this matter.

Sincerely,

Thorn Smith

Attachments

BERING SEA TURBOT FISHERY SUMMARY

W/Ending	2000	1999	1998	1997	1996
Turbot Allocation and Actual Catch					
Quota - Turbot					
TAC	6,030	6,030	10,050	6,030	4,667
ITAC	5,126	5,126	8,543	5,125	3,967
CDQ	452	452	754	0	0
Open Access	5,126	5,126	8,543	5,125	3,967

Note: Reserve (TAC - ITAC) generally reserved for trawl/other bycatch

Catch - Turbot					
Longline	3	3,499	6,174	4,672	3,977
Trawl	41	1,644	1,753	982	848
Pot	0	25	4	0	2
Total	44	5,168	7,931	5,654	4,827

Actual Halibut Bycatch

Halibut - Other (Open Access)					
"A"		63	61	53	94
"B"		13	0	0	0
Total		76	61	53	94

Halibut - Cod (Open Access)					
Allocation	766	598	777	840	800
"A"	157	268	264	253	383
"B"		0	37	83	44
"C"		144	451	501	361
Total		412	752	837	788

Halibut Bycatch Allocations

Cod Halibut Allocation	810	810	840	840	800
CDQ	61	61	63	0	0
"A"	457	457	458	495	475
"B"	0	0	37	40	40
"C"	291	291	282	305	285
Total (Open Access)	748	748	777	840	800
Transfer to Turbot		(150)	0	0	0
Total		598	777	840	800

Turbot Halibut Allocation

Turbot Halibut Allocation					
Turbot					
CDQ	7	7	4	0	0
"A"	83	41.5	56	60	100
"B"	0	41.5	0	0	0
Total Allocation	90	90	60	60	100
Transfer from Cod	100	150	0	0	0
Total	190	240	60	60	100

Turbot Halibut Mortality	19%	19%	12%	11%	
---------------------------------	------------	------------	------------	------------	--

2000 BSAI Trawl Fisheries PSC Council Recommended Apportionments and Seasonal Allowances

DRAFT

Fishery Group	Halibut Mortality Cap (mt)	Herring (mt)	Red King Crab (animals) Zone1	C. bairdi Zone1	C. bairdi Zone2	C. opilio COBLZ
Yellowfin sole	26.06% 958	9.14% 169	12.99% 12,600	37.61% 312,163	64.98% 1,637,448	71.49% 3,109,815
January 20 - March 31	29.63%					
April 1 - May 20*	22.00%					
May 21 - July 3	5.45%					
July 4 - Dec 31	42.82%					
Rocksole/other flatfish	22.91% 842	1.31% 24	72.17% 70,005	40.29% 334,407	21.66% 545,832	21.62% 940,470
January 20 - March 31	57.62%					
April 1 - July 3	20.95%					
July 4 - December 31	21.31%					
Turbot/sablefish/ Arrowtooth		0.59% 11				1.02% 44,370
Rockfish	2.03% 75	0.47% 9			0.42% 10,884	1.02% 44,370
July 4 - Dec 31						
Pacific cod	42.18% 1,550	1.31% 24	12.99% 12,600	20.17% 167,411	11.83% 298,116	3.07% 133,545
Pollock/mackerel/o.species	6.82% 250	87.18% 1,616	1.85% 1,795	1.93% 16,019	1.10% 27,720	1.78% 77,430
TOTAL	3,675	1,853	97,000	830,000	2,520,000	4,350,000

- 1) Includes 7.5% CDQ allocation.
- 2) Unused PSC allowances may be rolled into the following seasonal apportionment.
- 3) 35% of the red king crab PSC for the rock sole fishery is apportioned to the 56 - 56 o10' RKCSA strip.
- 4) Accounts for the reductions in halibut and crab PSCs due to ban on pollock bottom trawling
(halibut: -100 mt; RKC: -3,000; Z1 bairdi: -20,000; Z2 bairdi: -30,000; opilio: -150,000 crab)
- 5) Accounts for adjustments due to changes in biomass for herring, red king crab, Z2 bairdi, and opilio.
- 6) For herring PSC in pollock/mackerel/o.species category, 1,558 mt for midwater pollock fishery.

2000 BSAI Non-Trawl Fisheries PSC Bycatch Allowances and fixed gear Pacific cod seasonal apportionments

Fishery Group	Halibut Mortality (mt)	Seasonal Apportion of cod TAC (mt)
Pacific Cod	810	
Jan 1 - April 30	495	65,000 first tr.
May 1 - August 31	0	0 second tr.
Sept. 1 - Dec. 31	315	26,048 third tr.
Other Non-Trawl*	90	
May 1 - December 31	90	
Groundfish Pot	Exempt	
TOTAL	900 mt	91,048

Note: unused halibut PSC or P. cod TAC from first trimester will be rolled into the third trimester.
Any halibut PSC removed from the CDQ fisheries will be replaced from PSC apportioned from the third trimester.

- * Includes hook & line fisheries for rockfish and Greenland turbot.
Sablefish hook & line fisheries will be exempted from the halibut mortality cap.
Jig gear will also be exempted from the halibut mortality cap.

National Marine Fisheries Service
P.O. Box 21668
Juneau, Alaska 99802-1668

Prepared: 04/06/00 at 2:52 PM
NMFS/AKR Fish Management
(907) 586-7229

2000 GULF OF ALASKA GROUND FISH QUOTAS
AND PRELIMINARY CATCH IN ROUND METRIC TONS

Data are from Weekly Production and Observer Reports through 04/01/00
Quotas are based on Final Specifications

	TOTAL CATCH	QUOTA	REMAINING QUOTA	% TAKEN	LAST WK CATCH
WEST, CENT PLCK					
Pollock 610	11,189	11,247	58	99	12
Pollock 620	11,264	7,815	-3,449	144	545
Pollock 630	22,146	21,978	-168	101	424
WESTERN GULF					
Arrowtooth Flounder	1,756	5,000	3,244	35	160
Deep Water Flatfish	1	280	279	0	0
Shallow Water Flatfish	475	4,500	4,025	11	0
Flathead Sole	128	2,000	1,872	6	1
Rex Sole	418	1,230	812	34	42
Pacific Ocean Perch	5	1,240	1,235	0	1
Shortraker/Rougheye	25	210	185	12	5
Pelagic Shelf Rockfish	21	550	529	4	0
Northern Rockfish	52	630	578	8	0
Other Rockfish	0	20	20	0	0
Pacific Cod - Inshore	19,389	14,850	-4,539	131	3
Pacific Cod - Offshore	1,707	1,650	-57	103	18
Sablefish (Hook & Line)	151	1,472	1,321	10	29
Sablefish (Trawl)	27	368	341	7	4
Thornyhead	104	430	326	24	15
CENTRAL GULF					
Arrowtooth Flounder	1,766	25,000	23,234	7	204
Deep Water Flatfish	3	2,710	2,707	0	1
Shallow Water Flatfish	918	12,950	12,032	7	258
Flathead Sole	246	5,000	4,754	5	38
Rex Sole	395	5,660	5,265	7	46
Pacific Ocean Perch	92	9,240	9,148	1	0
Shortraker/Rougheye	13	930	917	1	4
Pelagic Shelf Rockfish	23	4,080	4,057	1	1
Northern rockfish	22	4,490	4,468	0	0
Other Rockfish	18	740	722	2	7
Pacific Cod - Inshore	25,530	24,538	-992	104	144
Pacific Cod - Offshore	319	2,726	2,407	12	0
Sablefish (Hook & Line)	149	4,584	4,435	3	80
Sablefish (Trawl)	16	1,146	1,130	1	11
Thornyhead	13	990	977	1	7
EASTERN GULF					
Shortraker/Rougheye	15	590	575	3	3
Pacific Cod - Inshore	248	2,887	2,639	9	4
Pacific Cod - Offshore	0	321	321	0	0
Thornyhead	16	940	924	2	3
WEST YAKUTAT					
Arrowtooth Flounder	2	2,500	2,498	0	0
Deep Water Flatfish	25	1,240	1,215	2	0
Shallow Water Flatfish	0	790	790	0	0
Flathead Sole	3	1,440	1,437	0	0
Rex Sole	0	1,540	1,540	0	0
Pacific Ocean Perch	2	840	838	0	0
Other Rockfish	11	250	239	4	0
Pelagic Shelf Rockfish	0	580	580	0	0
Pollock	1,744	2,340	596	75	105
Sablefish (Hook & Line)	108	1,919	1,811	6	61
Sablefish (Trawl)	1	288	287	0	0
SOUTHEAST					
Arrowtooth Flounder	7	2,500	2,493	0	0
Deep Water Flatfish	1	1,070	1,069	0	0
Shallow Water Flatfish	0	1,160	1,160	0	0
Flathead Sole	0	620	620	0	0
Rex Sole	0	1,010	1,010	0	0
Pacific Ocean Perch	0	1,700	1,700	0	0
Other Rockfish	8	3,890	3,882	0	1
Pelagic Shelf Rockfish	15	770	755	2	0
Pollock	5	6,460	6,455	0	0
Demersal Shelf Rockfish	146	340	194	43	1

Sablefish (Hook & Line)	142	3,553	3,411	4	38
ENTIRE GOA					
Other Species	3,456	14,215	10,759	24	71
Atka Mackerel	1	600	599	0	0

TOTALS:	104,337	236,607	132,270	44	2,350

National Marine Fisheries Service
P.O. Box 21668
Juneau, Alaska 99802-1668

Prepared: 04/06/00 at 2:52 PM
NMFS/AKR Fish Management
(907) 586-7229

2000 BERING SEA & ALEUTIANS GROUND FISH QUOTAS
AND PRELIMINARY CATCH IN ROUND METRIC TONS

Data are from Weekly Production and Observer Reports through 04/01/00
Quotas are based on Final Specifications

	TOTAL CATCH	QUOTA	REMAINING QUOTA	% TAKEN	LAST WK CATCH
BERING SEA					
Other Rockfish	40	314	274	13	4
Pacific Ocean Perch	29	2,210	2,181	1	0
Other Red Rockfish	45	165	120	27	1
Sablefish (Fixed Gear)	10	588	578	2	2
Sablefish (Trawl)	10	624	614	2	4
Greenland Turbot	74	5,764	5,690	1	5
Pollock - Inshore	194,571	194,769	198	100	143
Pollock - AFA Offshore	153,948	155,815	1,867	99	14,119
Pollock - AFA Mothership	37,349	38,954	1,605	96	0
Pollock - Incidental Ctch	13,893	51,255	37,362	27	924
ALEUTIAN ISLANDS					
Other Rockfish	94	583	489	16	5
Pacific Ocean Perch, East	107	2,886	2,779	4	3
Pacific Ocean Perch, Cent	161	3,247	3,086	5	18
Pacific Ocean Perch, West	178	5,245	5,067	3	30
Sharpchin/Northern	2,229	4,764	2,535	47	66
Shortraker/Rougheye Fixed	43	246	203	17	6
Shortraker/Rougheye Trawl	18	573	555	3	0
Atka Mackerel - Eastern	9,201	7,509	-1,692	123	0
- Jig	0	152	152	0	0
Atka Mackerel - Central	8,959	11,424	2,465	78	17
Atka Mackerel - Western	8,292	13,736	5,444	60	336
Sablefish (Fixed Gear)	62	1,459	1,397	4	28
Sablefish (Trawl)	0	515	515	0	0
Greenland Turbot	52	2,839	2,787	2	20
Pollock - Incidental Ctch	542	2,000	1,458	27	144
BERING SEA & ALEUTIANS					
Arrowtooth Flounder	901	111,350	110,449	1	144
Flathead Sole	4,489	44,755	40,266	10	291
Other Flatfish	7,094	71,242	64,148	10	1,299
Other Species	8,487	26,656	18,169	32	264
Pacific Cod (Trawl - C/P)	17,518	41,953	24,435	42	1,009
Pacific Cod (Trawl - C/V)	29,680	41,953	12,273	71	4,301
Pacific Cod (Fixed Gear)	59,303	65,000	5,697	91	2
Pacific Cod (Jig)	36	3,571	3,535	1	2
Rock Sole	37,491	114,546	77,055	33	654
Squid	297	1,675	1,378	18	2
Yellowfin Sole	12,437	104,773	92,336	12	2,571
BOGOSLOP					
Pollock - Incidental Ctch	4	1,000	996	0	2

TOTALS:	607,644	1,136,110	528,466	53	26,415

National Marine Fisheries Service
P.O. Box 21668
Juneau, Alaska 99802-1668

Prepared: 04/06/00 at 2:52 PM
NMFS/AKR Fish Management
(907) 586-7229

2000 GULF OF ALASKA REPORT ON DAP HARVEST
BY GEAR TYPE

Data are from Weekly Production and Observer Reports through 04/01/00

	TRAWL	H&L	POT	OTHER	TOTAL
WEST, CENT PLCK					
Pollock 610	11,153	32	5	0	11,190
Pollock 620	11,256	7	2	0	11,265
Pollock 630	21,819	322	5	0	22,146
WESTERN GULF					
Arrowtooth Flounder	1,710	44	3	0	1,757
Deep Water Flatfish	2	0	0	0	2
Shallow Water Flatfish	473	2	0	0	475
Flathead Sole	126	1	0	0	127
Rex Sole	418	0	0	0	418
Pacific Ocean Perch	5	0	0	0	5
Shortraker/Rougheye	9	17	0	0	26
Pelagic Shelf Rockfish	19	0	2	0	21
Northern Rockfish	51	0	0	0	51
Other Rockfish	0	0	0	0	0
Pacific Cod - Inshore	11,521	3,541	4,328	0	19,390
Pacific Cod - Offshore	133	1,173	400	0	1,706
Sablefish (Hook & Line)	0	151	0	0	151
Sablefish (Trawl)	27	0	0	0	27
Thornyhead	99	5	0	0	104
CENTRAL GULF					
Arrowtooth Flounder	1,371	387	7	0	1,765
Deep Water Flatfish	3	0	0	0	3
Shallow Water Flatfish	915	1	2	0	918
Flathead Sole	243	4	0	0	247
Rex Sole	395	0	0	0	395
Pacific Ocean Perch	92	0	0	0	92
Shortraker/Rougheye	5	8	0	0	13
Pelagic Shelf Rockfish	17	0	6	0	23
Northern rockfish	21	0	1	0	22
Other Rockfish	6	12	0	0	18
Pacific Cod - Inshore	8,190	6,337	11,003	0	25,530
Pacific Cod - Offshore	2	0	317	0	319
Sablefish (Hook & Line)	0	149	0	0	149
Sablefish (Trawl)	16	0	0	0	16
Thornyhead	10	3	0	0	13
EASTERN GULF					
Shortraker/Rougheye	1	14	0	0	15
Pacific Cod - Inshore	0	164	83	0	247
Pacific Cod - Offshore	0	0	0	0	0
Thornyhead	8	8	0	0	16
WEST YAKUTAT					
Arrowtooth Flounder	0	2	0	0	2
Deep Water Flatfish	25	0	0	0	25
Shallow Water Flatfish	0	0	0	0	0
Flathead Sole	3	0	0	0	3
Rex Sole	0	0	0	0	0
Pacific Ocean Perch	2	0	0	0	2
Other Rockfish	0	11	0	0	11
Pelagic Shelf Rockfish	0	0	0	0	0
Pollock	1,744	0	0	0	1,744
Sablefish (Hook & Line)	0	108	0	0	108
Sablefish (Trawl)	1	0	0	0	1
SOUTHEAST					
Arrowtooth Flounder	0	7	0	0	7
Deep Water Flatfish	0	1	0	0	1
Shallow Water Flatfish	0	0	0	0	0
Flathead Sole	0	0	0	0	0
Rex Sole	0	0	0	0	0
Pacific Ocean Perch	0	0	0	0	0
Other Rockfish	0	9	0	0	9
Pelagic Shelf Rockfish	0	15	0	0	15
Pollock	0	5	0	0	5
Demersal Shelf Rockfish	0	146	0	0	146
Sablefish (Hook & Line)	0	142	0	0	142

ENTIRE GOA					
Other Species	1,060	2,064	332	0	3,456
Atka Mackerel	0	0	1	0	1

TOTALS:	72,951	14,892	16,497	0	104,340

National Marine Fisheries Service
 P.O. Box 21668
 Juneau, Alaska 99802-1668

Prepared: 04/06/00 at 2:52 PM
 NMFS/AKR Fish Management
 (907) 586-7229

2000 BERING SEA & ALEUTIANS REPORT ON DAP HARVEST
 BY GEAR TYPE

Data are from Weekly Production and Observer Reports through 04/01/00

	TRAWL	H&L	POT	OTHER	TOTAL
BERING SEA					
Other Rockfish	27	5	7	0	39
Pacific Ocean Perch	28	0	0	0	28
Other Red Rockfish	37	8	0	0	45
Sablefish (Fixed Gear)	0	10	1	0	11
Sablefish (Trawl)	11	0	0	0	11
Greenland Turbot	51	24	0	0	75
Pollock - Inshore	194,571	0	0	0	194,571
Pollock - AFA Offshore	153,948	0	0	0	153,948
Pollock - AFA Mothership	37,349	0	0	0	37,349
Pollock - Incidental Ctch	11,787	2,052	54	0	13,893
ALEUTIAN ISLANDS					
Other Rockfish	66	26	1	0	93
Pacific Ocean Perch, East	107	0	0	0	107
Pacific Ocean Perch, Cent	161	0	0	0	161
Pacific Ocean Perch, West	178	0	0	0	178
Sharpchin/Northern	2,209	20	0	0	2,229
Shortraker/Rougheye Fixed	0	43	0	0	43
Shortraker/Rougheye Trawl	17	0	0	0	17
Atka Mackerel - Eastern	9,188	2	10	0	9,200
- Jig	0	0	0	0	0
Atka Mackerel - Central	8,934	25	0	0	8,959
Atka Mackerel - Western	8,292	0	0	0	8,292
Sablefish (Fixed Gear)	0	61	0	0	61
Sablefish (Trawl)	0	0	0	0	0
Greenland Turbot	9	43	0	0	52
Pollock - Incidental Ctch	520	20	3	0	543
BERING SEA & ALEUTIANS					
Arrowtooth Flounder	747	153	1	0	901
Flathead Sole	4,378	110	1	0	4,489
Other Flatfish	7,066	27	1	0	7,094
Other Species	2,927	4,687	873	0	8,487
Pacific Cod (Trawl - C/P)	17,519	0	0	0	17,519
Pacific Cod (Trawl - C/V)	29,680	0	0	0	29,680
Pacific Cod (Fixed Gear)	0	40,907	18,395	0	59,302
Pacific Cod (Jig)	0	36	0	0	36
Rock Sole	37,483	6	1	0	37,490
Squid	297	0	0	0	297
Yellowfin Sole	12,305	64	68	0	12,437
BOGOSLOP					
Pollock - Incidental Ctch	2	2	0	0	4
TOTALS:					
	539,894	48,331	19,416	0	607,641

2000 GULF OF ALASKA GROUND FISH DISCARDS IN ROUND METRIC TONS
Data are from Weekly Production and Observer Reports through 04/01/00

	SHORESIDE			MOTHERSHIP		CATCHER-PROC	
	TOTAL CATCH	AT-SEA DISC	PLANT DISC	TOTAL CATCH	DISC	TOTAL CATCH	DISC
WEST. CENT PLCK							
Pollock 610	11000	582	1	0	0	190	63
Pollock 620	11233	424	0	30	20	0	0
Pollock 630	22035	565	0	100	42	11	4
WESTERN GULF							
Arrowtooth Flounder	365	320	0	0	0	1391	1129
Deep Water Flatfish	0	0	0	0	0	1	1
Shallow Water Flatfish	124	124	0	3	3	348	235
Flathead Sole	55	33	0	0	0	72	26
Rex Sole	5	4	0	0	0	413	12
Pacific Ocean Perch	3	3	0	0	0	3	2
Shortraker/Rougheye	0	0	0	0	0	26	12
Pelagic Shelf Rockfish	20	20	0	0	0	1	1
Northern Rockfish	21	21	0	0	0	30	30
Other Rockfish	0	0	0	0	0	0	0
Pacific Cod - Inshore	15489	28	15	1	0	3899	57
Pacific Cod - Offshore	0	0	0	207	0	1499	27
Sablefish (Hook & Line)	0	0	0	0	0	151	9
Sablefish (Trawl)	0	0	0	0	0	27	10
Thornyhead	0	0	0	0	0	103	31
CENTRAL GULF							
Arrowtooth Flounder	1182	732	0	0	0	584	547
Deep Water Flatfish	1	0	0	0	0	2	2
Shallow Water Flatfish	912	121	0	3	0	2	1
Flathead Sole	151	31	0	0	0	95	16
Rex Sole	18	7	0	0	0	377	4
Pacific Ocean Perch	4	2	0	0	0	88	88
Shortraker/Rougheye	12	3	0	0	0	0	0
Pelagic Shelf Rockfish	22	20	0	0	0	2	2
Northern rockfish	21	16	0	0	0	1	1
Other Rockfish	13	1	0	0	0	6	5
Pacific Cod - Inshore	24753	114	0	432	0	345	6
Pacific Cod - Offshore	0	0	0	0	0	319	0
Sablefish (Hook & Line)	97	21	0	0	0	52	0
Sablefish (Trawl)	12	11	0	0	0	4	3
Thornyhead	3	2	0	0	0	10	0
EASTERN GULF							
Shortraker/Rougheye	15	0	1	0	0	0	0
Pacific Cod - Inshore	247	0	3	0	0	0	0
Pacific Cod - Offshore	0	0	0	0	0	0	0
Thornyhead	16	0	0	0	0	0	0
WEST YAKUTAT							
Arrowtooth Flounder	2	2	0	0	0	0	0
Deep Water Flatfish	25	0	0	0	0	0	0
Shallow Water Flatfish	0	0	0	0	0	0	0
Flathead Sole	3	3	0	0	0	0	0
Rex Sole	0	0	0	0	0	0	0
Pacific Ocean Perch	2	0	0	0	0	0	0
Other Rockfish	11	0	0	0	0	0	0
Pelagic Shelf Rockfish	0	0	0	0	0	0	0
Pollock	1744	0	0	0	0	0	0
Sablefish (Hook & Line)	102	0	0	0	0	5	0
Sablefish (Trawl)	1	0	0	0	0	0	0
SOUTHEAST							
Arrowtooth Flounder	7	7	0	0	0	0	0
Deep Water Flatfish	1	0	0	0	0	0	0
Shallow Water Flatfish	0	0	0	0	0	0	0
Flathead Sole	0	0	0	0	0	0	0
Rex Sole	0	0	0	0	0	0	0
Pacific Ocean Perch	0	0	0	0	0	0	0
Other Rockfish	9	0	0	0	0	0	0
Pelagic Shelf Rockfish	15	0	0	0	0	0	0
Pollock	5	5	0	0	0	0	0
Demersal Shelf Rockfish	146	0	0	0	0	0	0
Sablefish (Hook & Line)	130	0	0	0	0	12	1

ENTIRE GOA

Other Species	3140	2885	0	1	1	314	311
Atka Mackerel	1	1	0	0	0	0	0
<hr/>							
TOTALS:	93173	6108	20	777	66	10383	2636

2000 BERING SEA & ALEUTIANS GROUND FISH DISCARDS IN ROUND METRIC TONS
Data are from Weekly Production and Observer Reports through 04/01/00

	SHORESIDE			MOTHERSHIP		CATCHER-PROC	
	TOTAL CATCH	AT-SEA DISC	PLANT DISC	TOTAL CATCH	DISC	TOTAL CATCH	DISC
BERING SEA							
Other Rockfish	10	10	0	0	0	30	17
Pacific Ocean Perch	11	11	0	0	0	18	6
Other Red Rockfish	25	25	0	0	0	20	13
Sablefish (Fixed Gear)	0	0	0	0	0	11	0
Sablefish (Trawl)	0	0	0	0	0	11	3
Greenland Turbot	16	16	0	0	0	58	41
Pollock - Inshore	194571	522	0	0	0	0	0
Pollock - AFA Offshore	0	0	0	0	0	153948	190
Pollock - AFA Mothership	0	0	0	37349	26	0	0
Pollock - Incidental Ctch	2710	1716	0	135	79	11049	4419
ALEUTIAN ISLANDS							
Other Rockfish	2	2	0	3	3	89	59
Pacific Ocean Perch, East	1	1	0	1	1	105	104
Pacific Ocean Perch, Cent	0	0	0	2	2	158	121
Pacific Ocean Perch, West	0	0	0	0	0	178	136
Sharpchin/Northern	3	3	0	18	18	2208	2129
Shortraker/Rougheye Fixed	0	0	0	0	0	43	36
Shortraker/Rougheye Trawl	0	0	0	0	0	17	16
Atka Mackerel - Eastern	11	10	0	0	0	9190	198
- Jig	0	0	0	0	0	0	0
Atka Mackerel - Central	0	0	0	1	1	8958	526
Atka Mackerel - Western	0	0	0	0	0	8293	619
Sablefish (Fixed Gear)	1	0	0	0	0	61	1
Sablefish (Trawl)	0	0	0	0	0	0	0
Greenland Turbot	1	1	0	1	1	50	20
Pollock - Incidental Ctch	289	287	0	2	0	251	121
BERING SEA & ALEUTIANS							
Arrowtooth Flounder	48	40	0	22	22	831	748
Flathead Sole	488	322	0	167	135	3834	1771
Other Flatfish	237	50	0	5	4	6852	6648
Other Species	1159	1123	0	229	226	7098	6483
Pacific Cod (Trawl - C/P)	0	0	0	0	0	17519	261
Pacific Cod (Trawl - C/V)	24156	126	0	5524	58	0	0
Pacific Cod (Fixed Gear)	12812	75	0	3628	9	42863	1490
Pacific Cod (Jig)	36	0	0	0	0	0	0
Rock Sole	1035	744	0	321	278	36134	19912
Squid	0	0	0	0	0	297	277
Yellowfin Sole	142	30	0	86	71	12210	3574
BOGOSLOP							
Pollock - Incidental Ctch	3	0	0	0	0	2	0
TOTALS:	237767	5114	0	47494	934	322386	49939

NMFS/AKR
 04/06/00
 14:53:50

2000 GULF OF ALASKA FISHERIES
 TRAWL HALIBUT BYCATCH MORTALITY (METRIC TONS)
 Week Ending: 04/01/00

WED	SHALLOW WATER COMPLEX		DEEP WATER COMPLEX		GRAND TOTAL
	WEEK TOTAL	CUMULATIVE TOTAL	WEEK TOTAL	CUMULATIVE TOTAL	
01/15/00	0	0	0	0	0
01/22/00	2	2	1	1	3
01/29/00	20	22	6	7	29
02/05/00	14	36	3	10	46
02/12/00	17	53	6	15	68
02/19/00	34	87	5	20	108
02/26/00	108	196	7	27	223
03/04/00	105	300	5	33	333
03/11/00	21	321	4	37	358
03/18/00	6	326	12	49	375
03/25/00	3	329	9	58	387
04/01/00	27	356	10	68	424

CAP:	600	CAP:	400
% OF CAP:	59%	% OF CAP:	17%
REMAINING:	244	REMAINING:	332

SEASON	SEASONAL HALIBUT BYCATCH MORTALITY CAPS		
	SHALLOW COMPLEX	DEEP COMPLEX	TOTAL
Jan 01 - Mar 31	500 MT	100 MT	600 MT
Apr 01 - Jul 03	100 MT	300 MT	400 MT
Jul 04 - Sep 30	200 MT	400 MT	600 MT
Oct 01 - Dec 31	- No Apportionment	-	400 MT
TOTALS	800 MT	800 MT	2000 MT

Balance of 4th Quarter available for all trawl fisheries

Shallow Water Complex = pollock, Pacific cod, shallow-water flatfish, flathead sole, Atka mackerel, and "other species."
 Deep Water Complex = sablefish, rockfish, rex sole, arrowtooth flounder, and deep-water flatfish.

NMFS/AKR
04/06/00
14:53:49

2000 GULF OF ALASKA FISHERIES
HOOK & LINE HALIBUT BYCATCH MORTALITY (METRIC TONS)
Week Ending: 04/01/00

OTHER HOOK & LINE FISHERIES		
WED	WEEKLY	TOTAL
01/01/00	1	1
01/08/00	25	25
01/15/00	26	51
01/22/00	17	67
01/29/00	16	84
02/05/00	22	106
02/12/00	33	139
02/19/00	50	189
02/26/00	54	243
03/04/00	23	266
03/11/00	2	268
03/18/00	1	268
03/25/00	1	269
04/01/00	0	269
CAP:		250
% OF SEASONAL CAP:		108%
REMAINING:		-19

2000 HOOK-AND-LINE GROUND FISH FISHERIES HALIBUT MORTALITY CAPS

SEASON	OTHER HOOK AND LINE FISHERIES
Jan 01 - May 17	250 MT
May 18 - Aug 31	15 MT
Sep 15 - Dec 31	25 MT
Annual Total:	290 MT

Sablefish fishery is exempt from halibut bycatch restrictions.
Other hook and line fisheries are all H&L fisheries except
sablefish and demersal shelf rockfish in the Southeast District.

Halibut mortality for the demersal shelf rockfish fishery,
Southeast District is not listed due to insufficient observer
coverage.

NMFS/AKR
04/06/00
14:53:50

2000 GULF OF ALASKA FISHERIES
CHINOOK & OTHER SALMON BYCATCH
Week Ending:04/01/00

TRAWL GEAR

WEEK	CHINOOK SALMON		'OTHER' SALMON	
	WEEKLY NUMBER	CUMULATIVE NUMBER	WEEKLY NUMBER	CUMULATIVE NUMBER
01/15	0	0	0	0
01/22	522	523	62	62
01/29	2,505	3,027	80	143
02/05	1,705	4,732	128	271
02/12	2,411	7,143	133	405
02/19	799	7,943	46	451
02/26	273	8,216	15	466
03/04	597	8,814	0	466
03/11	22	8,836	3	469
03/18	679	9,515	105	575
03/25	481	9,996	43	618
04/01	112	10,107	27	645

NOTE: No PSC Limits apply to salmon.

Data based on observer reports, extrapolated to total groundfish harvest. Estimates for all weeks may change due to incorporation of late or corrected data.

NMFS/AKR
04/06/00
14:53:20

2000 BERING SEA/ALEUTIAN ISLANDS FISHERIES
PROHIBITED SPECIES BYCATCH
Week Ending: 04/01/00

TRAWL HERRING, BSAI

Fishery group	Herring (mt)	Cap (mt)	%
Midwater pollock	1	1,616	0%
Pacific cod	0	24	1%
Yellowfin sole	0	169	0%
Rockfish	0	9	0%
Other	0	38	0%
Rock sole/Other flatfish	0	24	0%
GTRB/ARTH/SABL	0	11	0%
Total:	1	1,891	0%

TRAWL SALMON, BSAI

Fishery group	Chinook (#'s)	Other (#'s)	Total (#'s)
Midwater pollock	2,729	172	2,902
Bottom pollock	0	0	0
Pacific cod	2,005	134	2,139
Yellowfin sole	0	0	0
Rock sole/Other flatfish	1	0	1
Rockfish	0	0	0
Other	256	30	285
Seasonal Total:	4,991	336	5,327

TRAWL BAIRDI TANNER CRAB

Fishery group	ZONE 1			ZONE 2		
	Crabs (#'s)	Cap (#'s)	%	Crabs (#'s)	Cap (#'s)	%
Rock sole/Other flatfish	189,703	316,780	60%	14,487	510,905	3%
Pacific cod	41,065	158,587	26%	10,736	279,041	4%
Yellowfin sole	12,451	295,708	4%	63,902	1,532,715	4%
Pollock/AMCK/Other species	20	15,175	0%	152	25,946	1%
Rockfish	0	0	0%	0	10,143	0%
GTRB/ARTH/SABL	0	0	0%	0	0	0%
Total:	243,239	786,250	31%	89,277	2,358,750	4%

TRAWL C. OPILIO TANNER CRAB in the COBLZ AREA

Fishery group	Crabs (#'s)	Cap (#'s)	%
Rock sole/Other flatfish	2,818	899,932	0%
Pacific cod	597	127,789	0%
Yellowfin sole	101,385	2,975,771	3%
Pollock/AMCK/Other species	78	74,092	0%
Rockfish	0	42,458	0%
GTRB/ARTH/SABL	0	42,458	0%
Total:	104,878	4,162,500	3%

TRAWL RED KING CRAB

Fishery group	ZONE 1		
	Crabs (#'s)	Cap (#'s)	%
Rock sole/Other flatfish	50,651	43,392	117%
Pacific cod	3,894	12,016	32%
Yellowfin sole	1,047	12,015	9%
Pollock/AMCK/Other species	0	1,711	0%
Total:	55,592	69,134	80%

NMFS/AKR
04/06/00
14:53:30

2000 BERING SEA / ALEUTIAN ISLANDS FISHERIES
TRAWL HALIBUT BYCATCH MORTALITY (METRIC TONS)

WED	PACIFIC COD	YELLOWFIN SOLE	ROCK SOLE/ FLATHEAD SOLE/ OTHER FLATFISH	PLCK/AMCK/ OTHER	ROCKFISH	ARROWTOOTH/ SABLEFISH/ TURBOT
01/22/00	40	0	6	4	0	0
01/29/00	26	0	129	6	0	0
02/05/00	53	0	67	3	0	0
02/12/00	22	0	61	3	0	0
02/19/00	74	0	37	3	0	0
02/26/00	50	0	65	3	0	0
03/04/00	26	0	39	4	0	0
03/11/00	36	9	3	2	0	0
03/18/00	51	32	8	9	0	0
03/25/00	63	29	5	2	0	2
04/01/00	45	22	10	2	0	0
	485	93	429	40	0	2
SEASONAL						
CAP:	1,473	470	628	238	0	0
% OF CAP:	33%	20%	68%	17%	0%	0%
REMAINING:	988	377	199	198	0	-2
ANNUAL CAP:	1,473	910	800	238	71	0
% OF CAP:	33%	10%	54%	17%	0%	0%

TOTAL HALIBUT MORTALITY : 1,049
TOTAL FINAL HALIBUT CAP : 3,492

NMFS/AKR
04/06/00

2000 BERING SEA / ALEUTIAN ISLANDS FISHERIES
FIXED GEAR HALIBUT BYCATCH MORTALITY (METRIC TONS)

WED	PACIFIC COD HOOK & LINE		OTHER SPECIES HOOK & LINE, JIG		ALL GROUND FISH POT GEAR	
	WEEKLY	TOTAL	WEEKLY	TOTAL	WEEKLY	TOTAL
01/01/00	1	1	0	0	0	0
01/08/00	12	13	0	0	0	0
01/15/00	20	33	0	0	0	0
01/22/00	12	44	0	0	0	0
01/29/00	12	56	0	0	0	1
02/05/00	16	72	0	0	1	1
02/12/00	16	88	0	0	0	2
02/19/00	19	106	0	0	0	2
02/26/00	21	127	0	0	0	2
03/04/00	16	143	0	0	0	2
03/11/00	12	156	0	0	0	3
03/18/00	1	156	0	0	0	3
03/25/00	0	156	2	2	0	3
04/01/00	0	156	0	2	0	3

PCOD SEASONAL CAP: 457 OTHER SEASONAL CAP: 84 Pot gear is exempt
 % OF SEASONAL CAP: 34% % OF SEASONAL CAP: 3% from bycatch allowances

REMAINING PCOD: 301 REMAINING OTHER: 82

2000 BSAI NON-TRAWL PACIFIC COD FISHERY HALIBUT BYCATCH ALLOWANCES

(Jan 01 - Apr 30)	457 MT
(May 01 - Sep 14)	0 MT
(Sep 15 - Dec 31)	291 MT
Annual Total	748 MT

APRIL, 2000

**NMFS FISHERIES
MANAGEMENT
REPORT**



GOA REPORTING AREAS

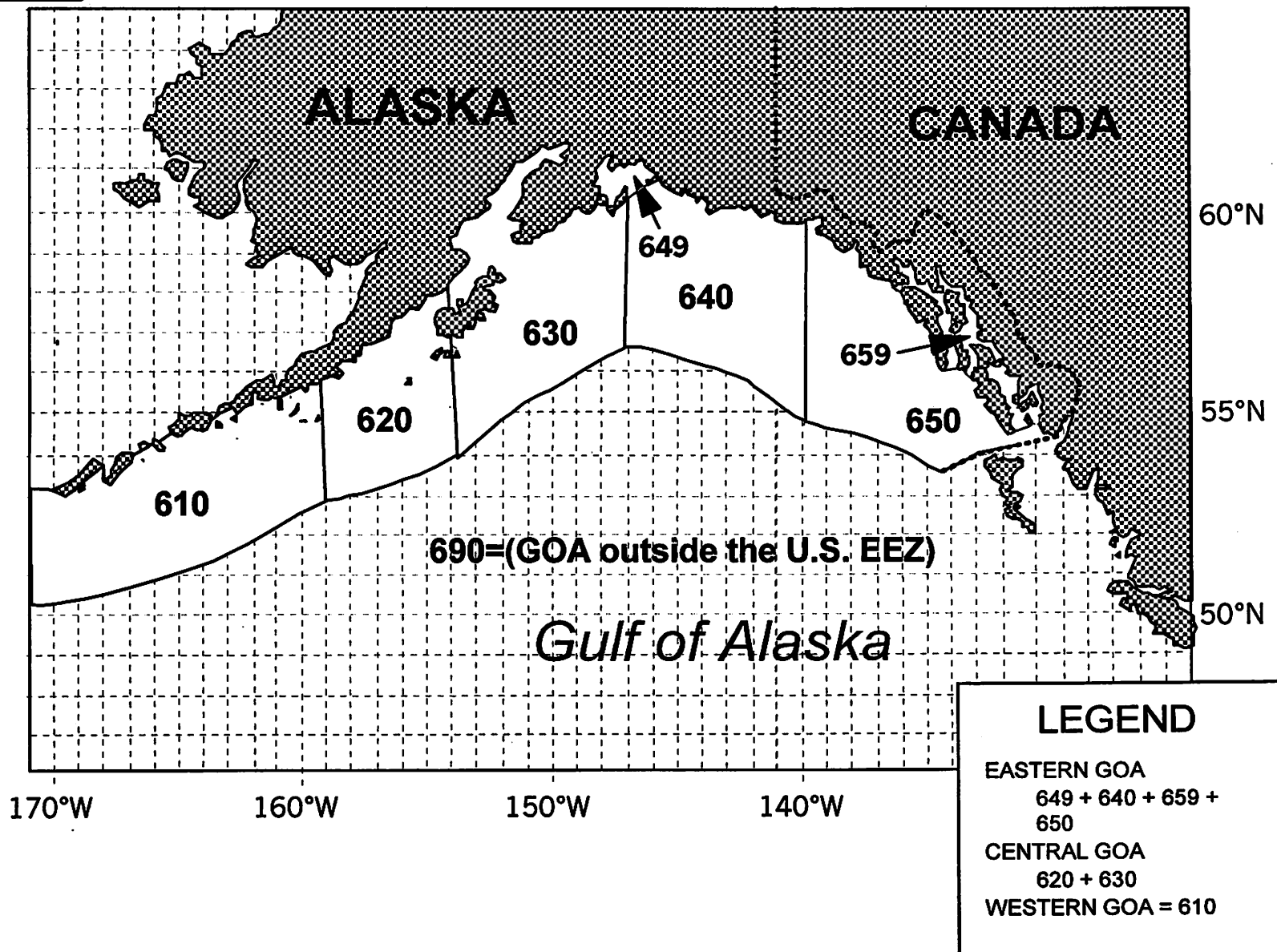

2000 GOA FISHERIES: WESTERN & CENTRAL POLLOCK A & B SEASONS (sheet 1 of 2)

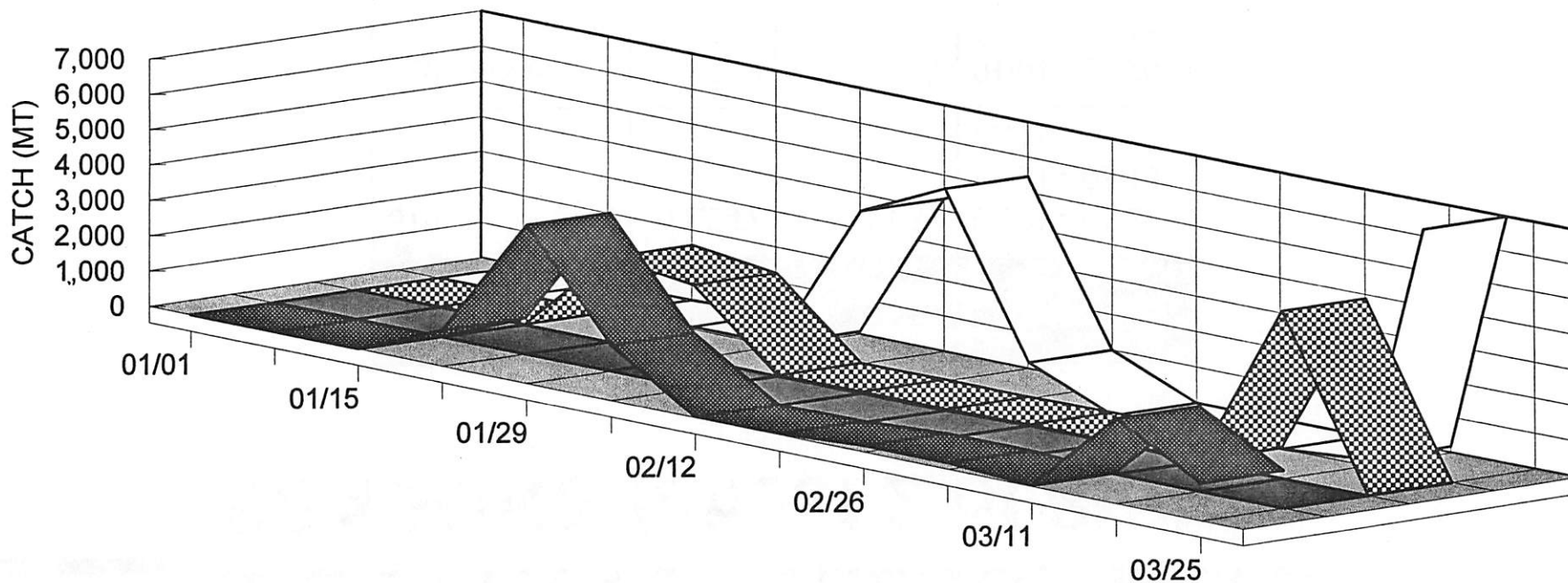
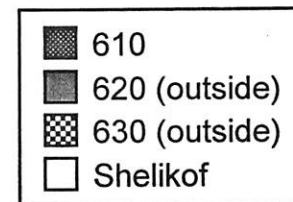

(through 3/25/00)

2000 GOA FISHERIES: WESTERN & CENTRAL POLLOCK A & B SEASONS (sheet 2 of 2)

	A/B TAC	CATCH	CLOSED
610	11,247	11,034	01/01 - 01/20 01/31 - 03/15 03/18
620 (outside)	819	150	01/01 - 01/20 01/27 - 03/15 03/15
630 (outside)	7,987	9,562	01/01 - 01/20 01/25 - 03/15 03/17
Shelikof Strait	20,987	21,262	01/01 - 01/20 02/10 - 03/15 03/25

2000 GOA INSHORE & OFFSHORE PACIFIC COD FISHERIES (sheet 1 of 2)

Western GOA

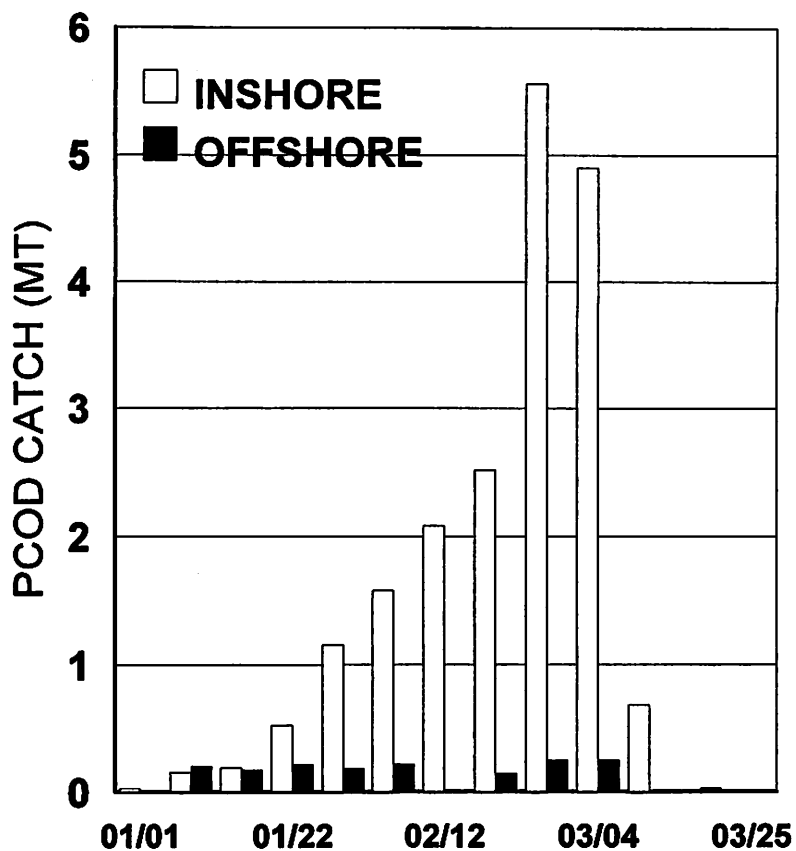

Central GOA

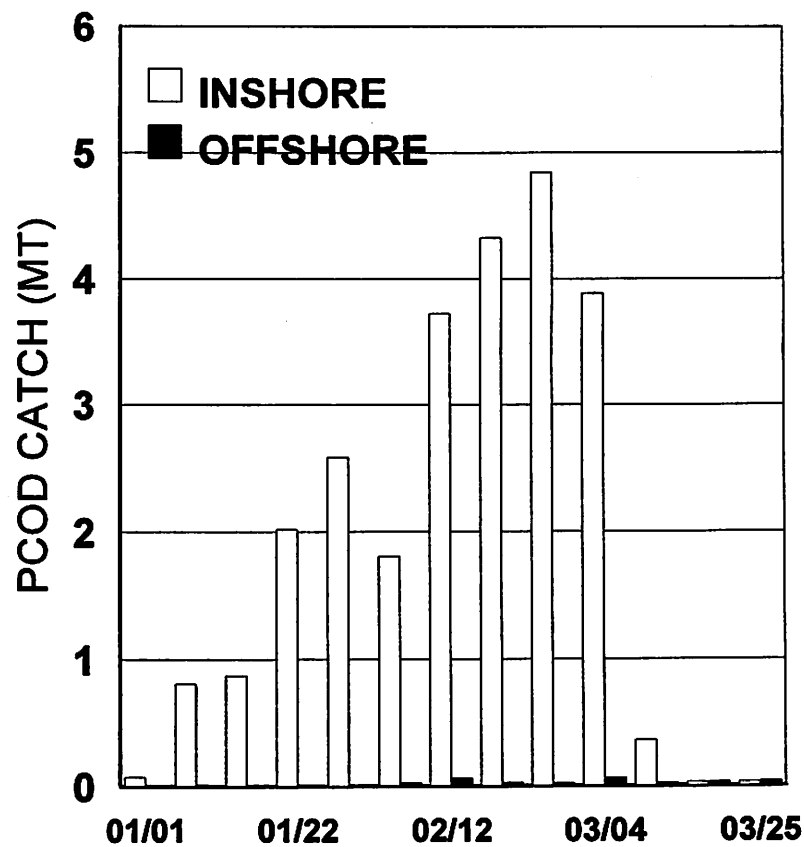

2000 GOA INSHORE & OFFSHORE PACIFIC COD FISHERIES INSEASON ACTIONS (sheet 2 of 2)

	TAC		Catch	Closed
	Initial	Final		
Western GOA Inshore (610)	14,850	18,563	19,404	03/04
Western GOA Offshore (610)	1,650	2,063	1,689	02/07
Central GOA Inshore (620, 630)	24,538	30,672	25,395	03/04
Central GOA Offshore (620, 630)	2,726	3,408	319	

2000 FIRST QUARTER GOA GROUND FISH CATCH & HALIBUT MORTALITY BY GEAR & TARGET

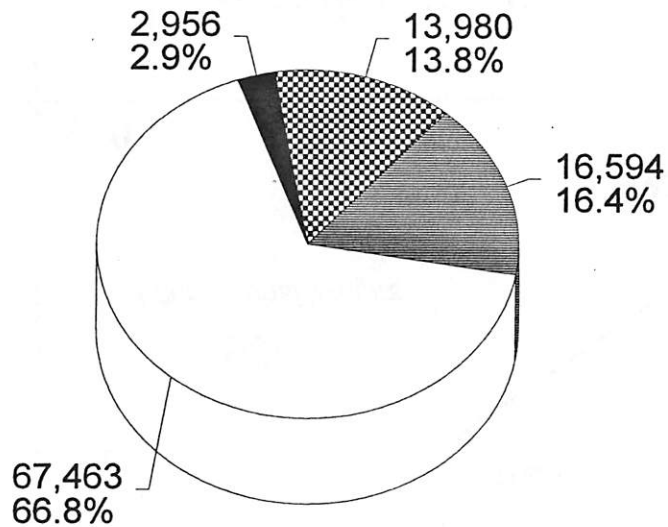

GROUND FISH (MT)
Total: 100,993

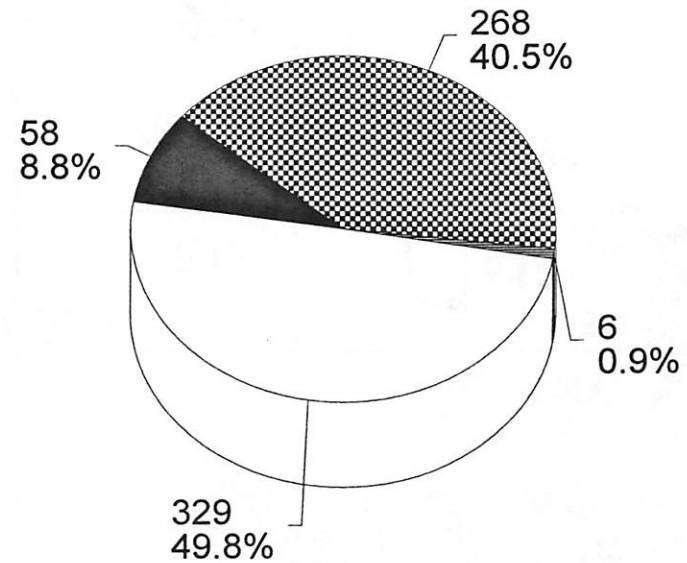

HALIBUT MORTALITY (MT)
Total: 661



SW COMPLEX = shallow water complex
pollock, Pacific cod, shallow water flatfish,
flathead sole, Atka mackerel, and "other species"
DW COMPLEX = deep water complex; sablefish,
rockfish, rex sole, Arrowtooth flounder, and deep
water flatfish. Pot is exempt.

H&L & POT
CLOSED 03/09

BSAI REPORTING AREAS

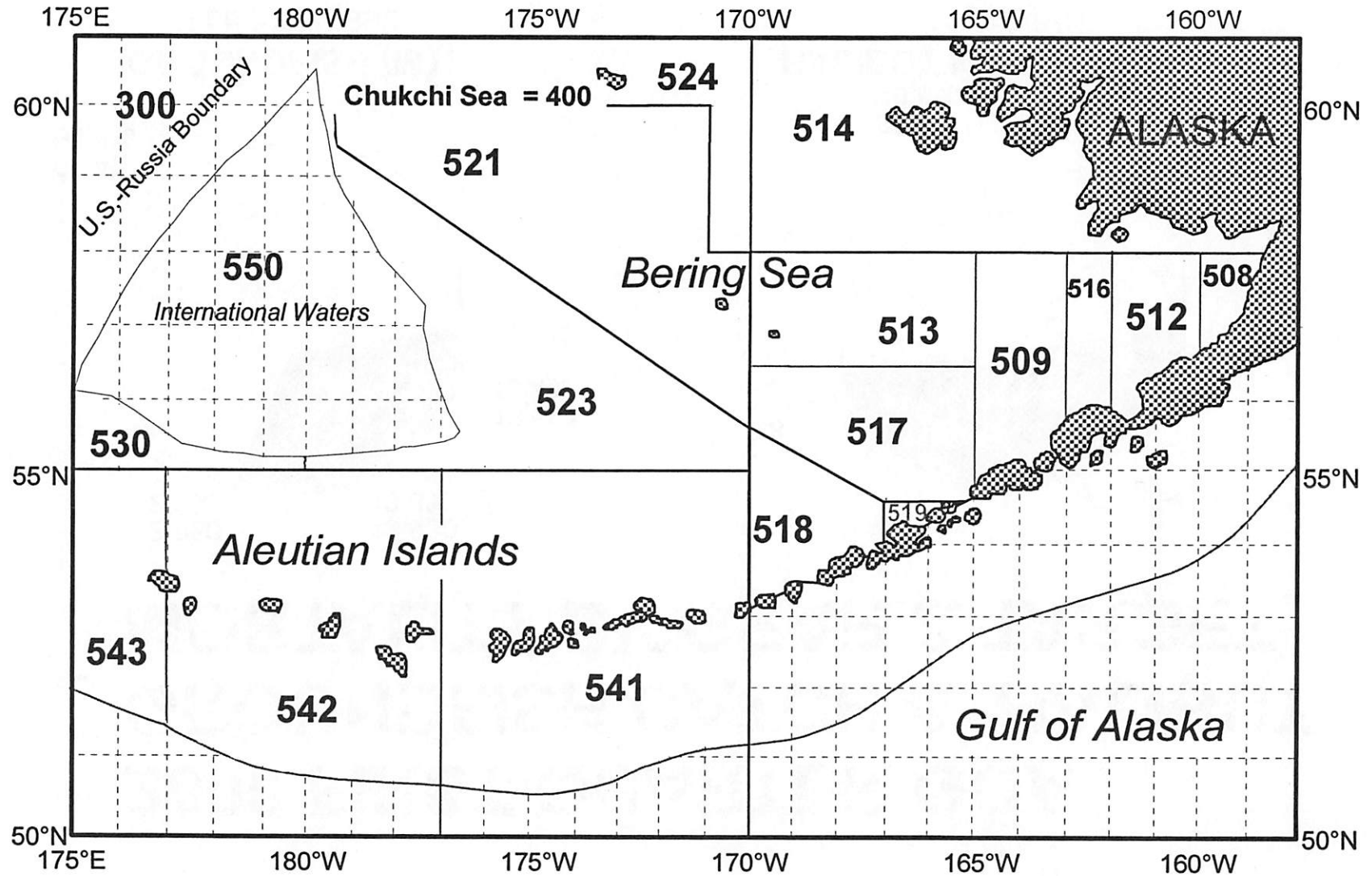

2000 BSAI FIXED GEAR PACIFIC COD CATCH

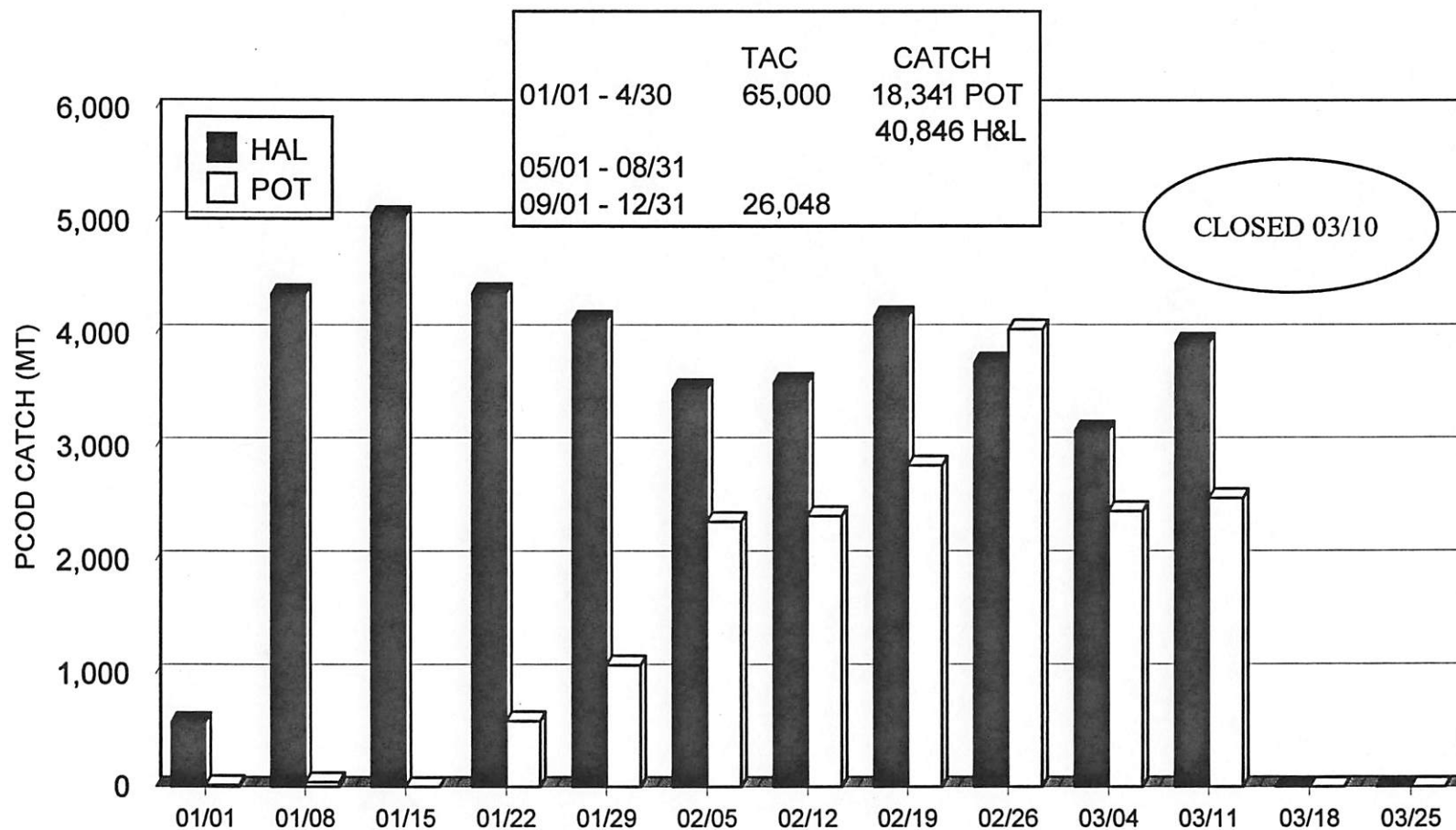

2000 BSAI FIRST SEASON H&L/POT GROUND FISH CATCH & HALIBUT MORTALITY

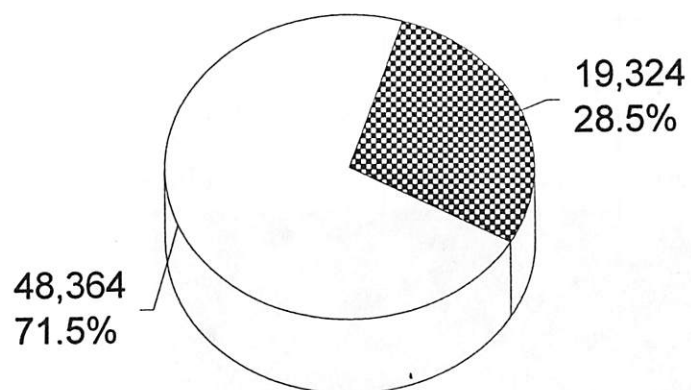

GROUND FISH (MT)

Total: 67,688

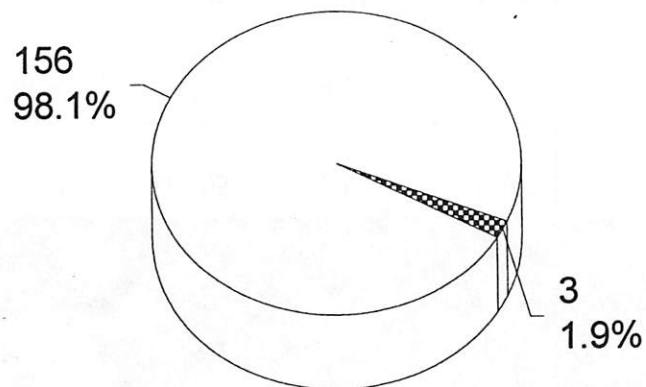

HALIBUT MORTALITY (MT)

Total: 159

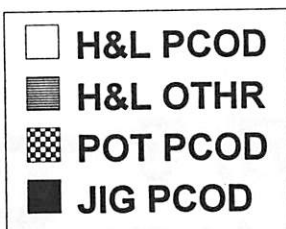

PCOD = Pacific cod

OTHR = other non-trawl (predominately H&L Greenland turbot)

Jig and pot gear and H&L sablefish fisheries are EXEMPT from halibut bycatch restrictions

2000 AFA BERING SEA POLLOCK 'A' & 'B' SEASONS FISHERIES

AFA	'A' & 'B' SEASONS DIRECTED FISHING ALLOWANCE (DFA)	TOTAL CATCH (MT)	'A' SEASON SCA			'B' SEASON SCA	
			LIMIT	CATCH	% DFA TAKEN INSIDE SCA	LIMIT	CATCH
Inshore processors	194,769	193,851	81,802	71,695	36.81	21,267	0
Catcher/ processors	155,815	139,834	38,564	38,448	24.68	12,854	0
Mothership	38,954	37,349	14,607	14,695	37.72	4,869	0
TOTALS	440,794	371,034	166,751	124,838	28.32	55,497	0

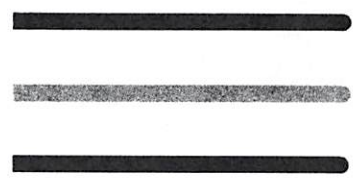

PERCENT OF 'A' SEASON POLLOCK TAKEN BY WEEK: 1998, 1999, 2000

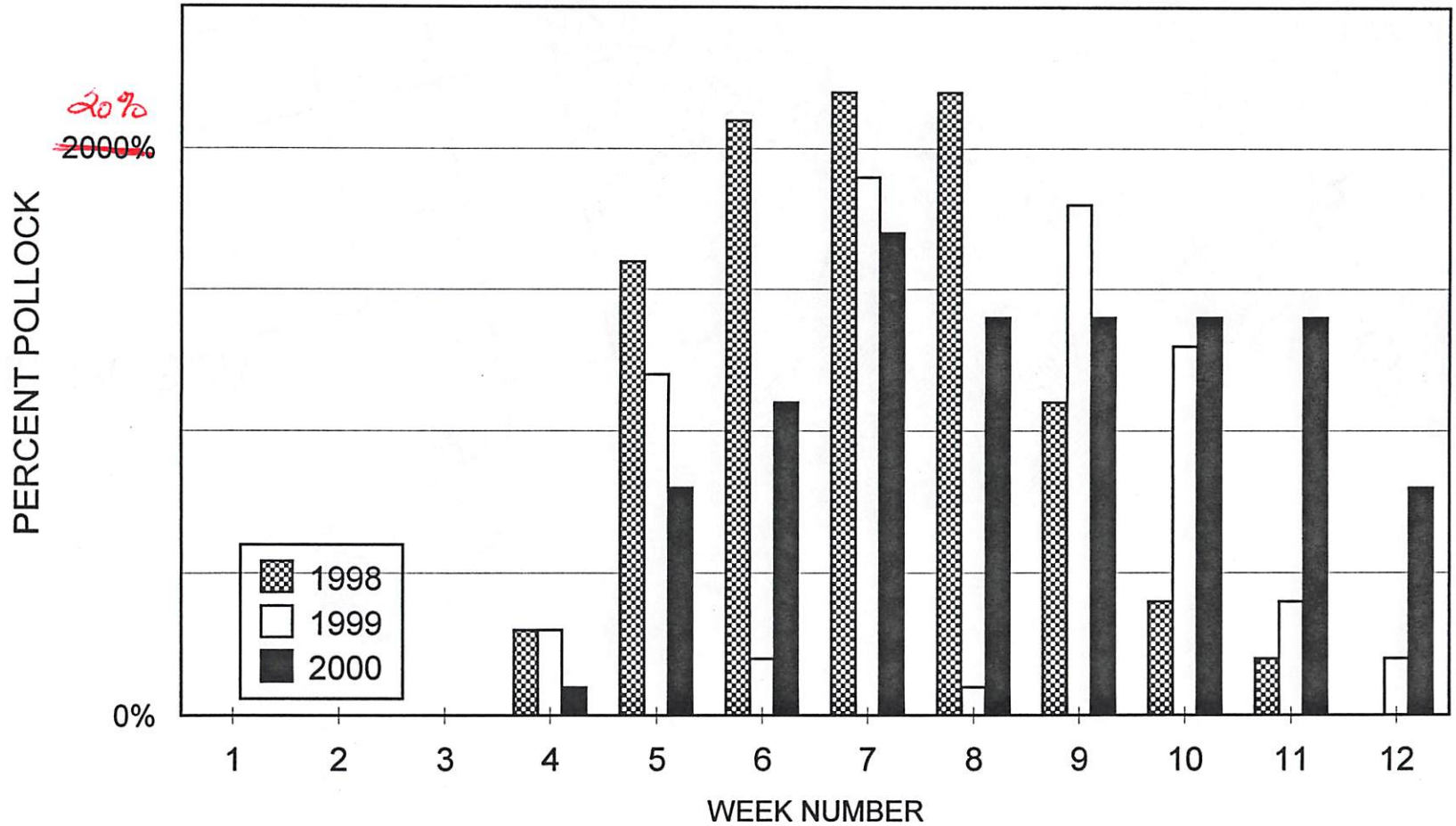







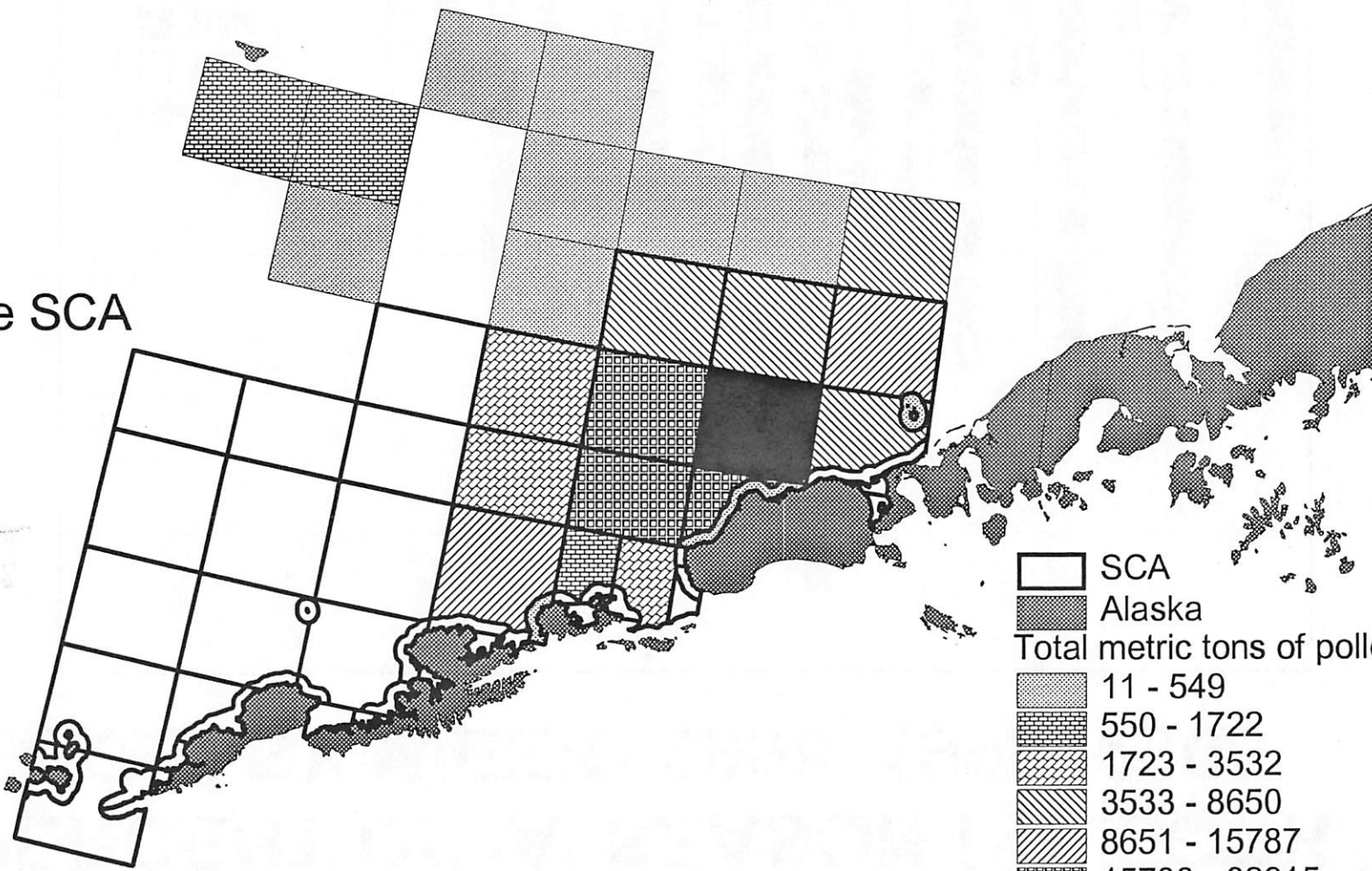

A-season pollock reported by the inshore fleet in 1998



94.5% inside SCA



-  SCA
-  Alaska
- Total metric tons of pollock
-  11 - 549
-  550 - 1722
-  1723 - 3532
-  3533 - 8650
-  8651 - 15787
-  15788 - 32915
-  32916 - 60640

A-season pollock reported by the inshore fleet in 1999.



70.7% inside SCA

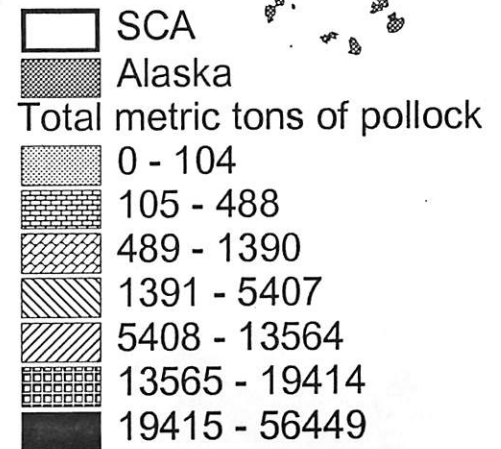
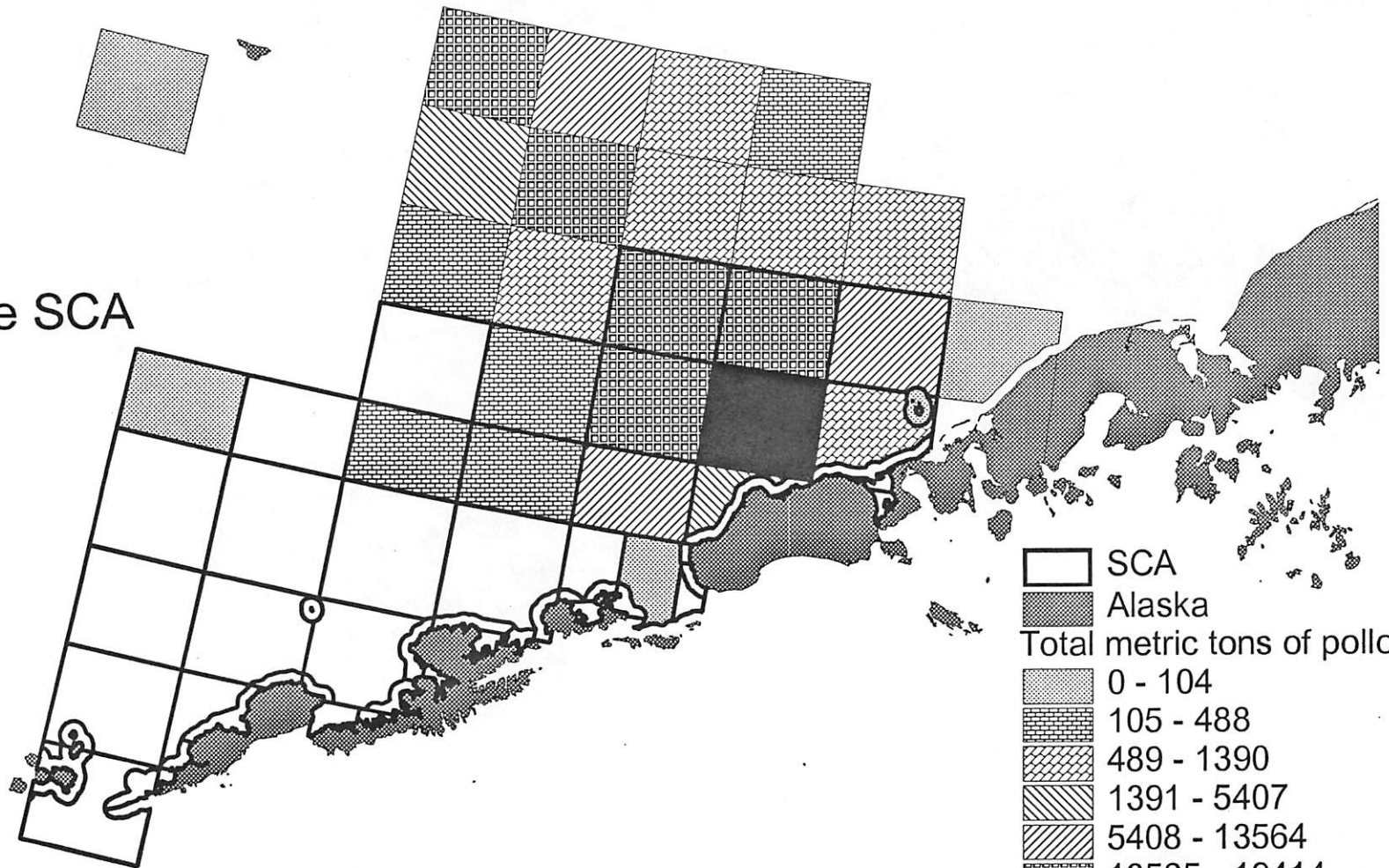

A-season pollock reported by the inshore fleet in 2000.



39.6% inside SCA

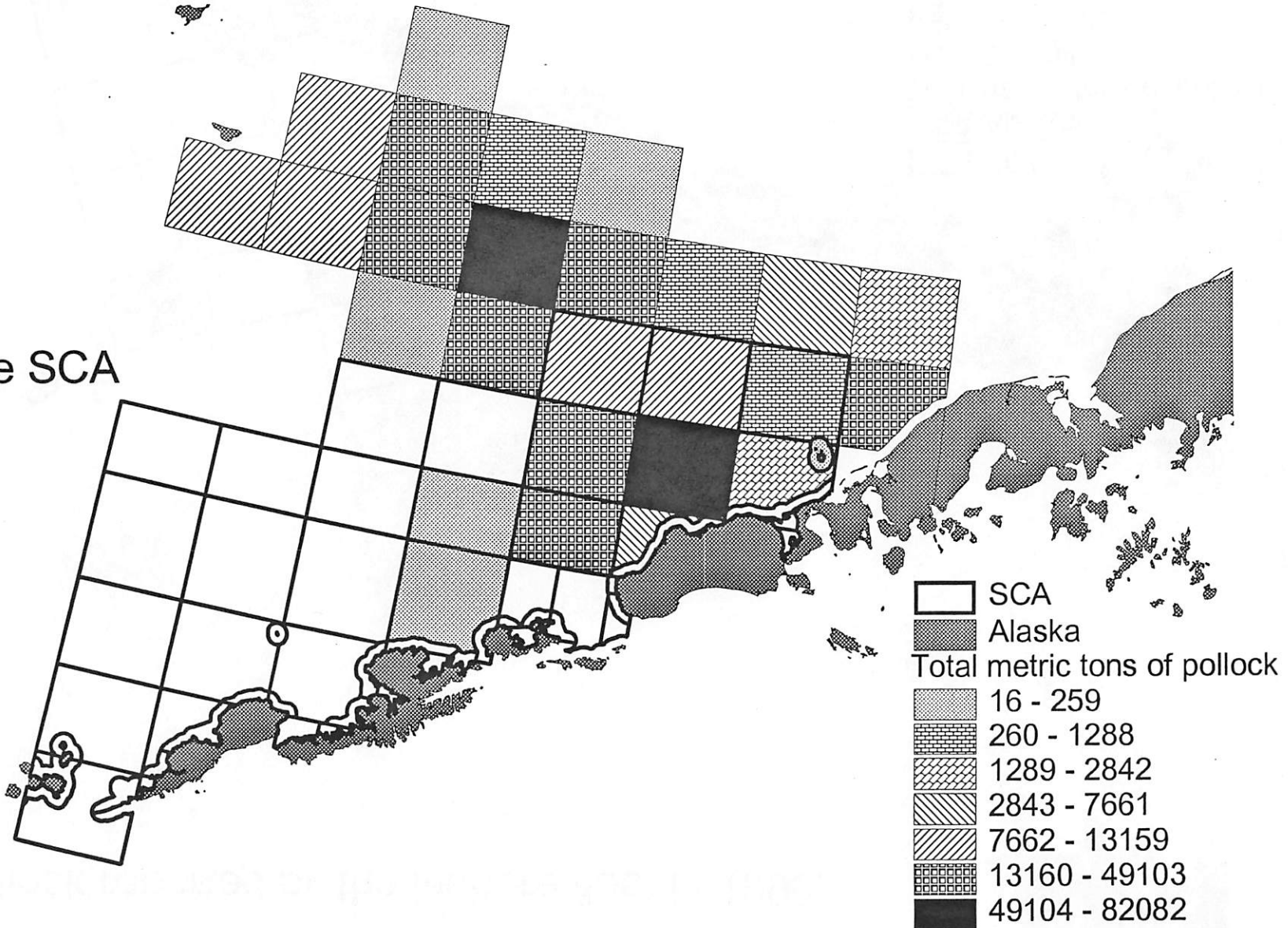

A-season pollock catch by the mothership and catcher/processor fleet in 1998.

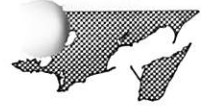

88.7% in SCA

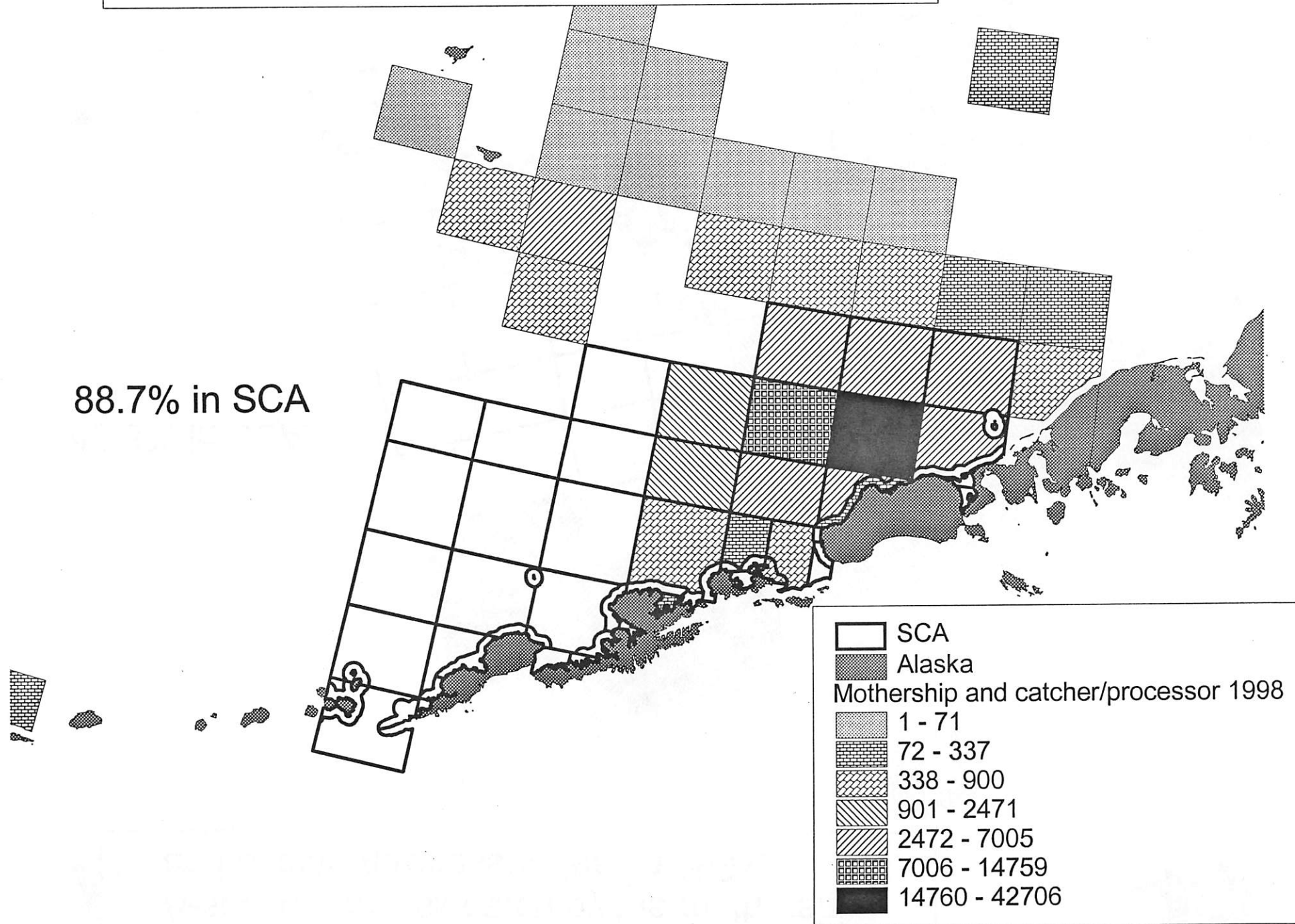

A-season pollock catch by the mothership and catcher/processor fleet in 1999.

40.8% in SCA

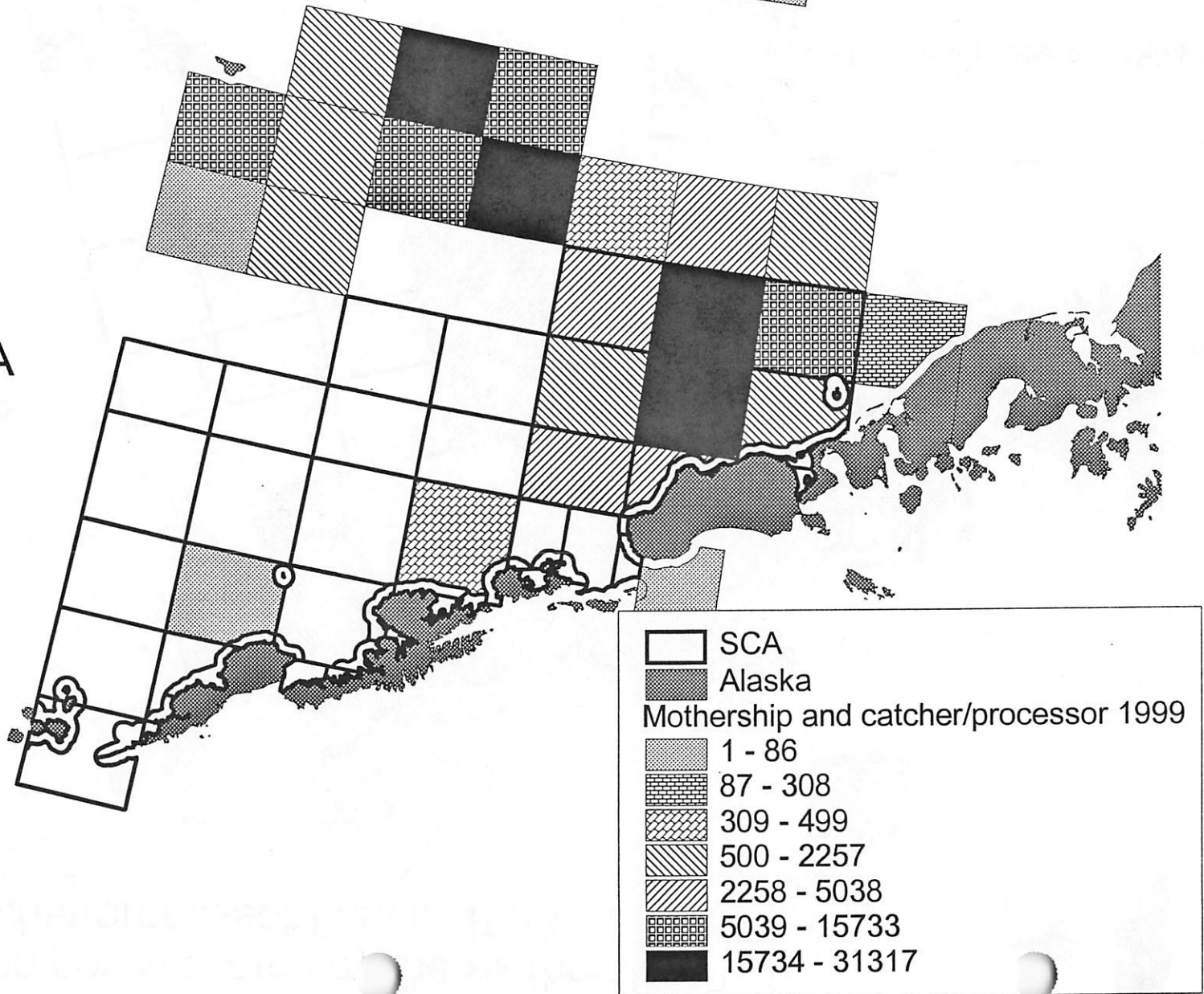

A-season pollock catch by the mothership and catcher/processor fleet in 2000.

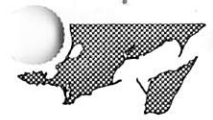

27.3% in SCA

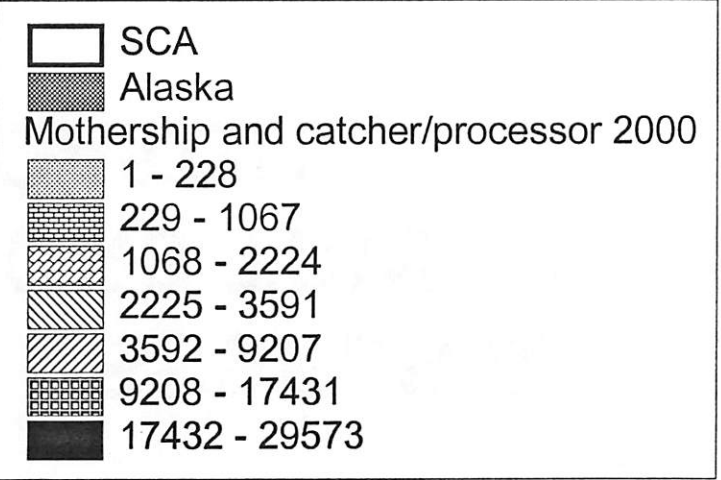
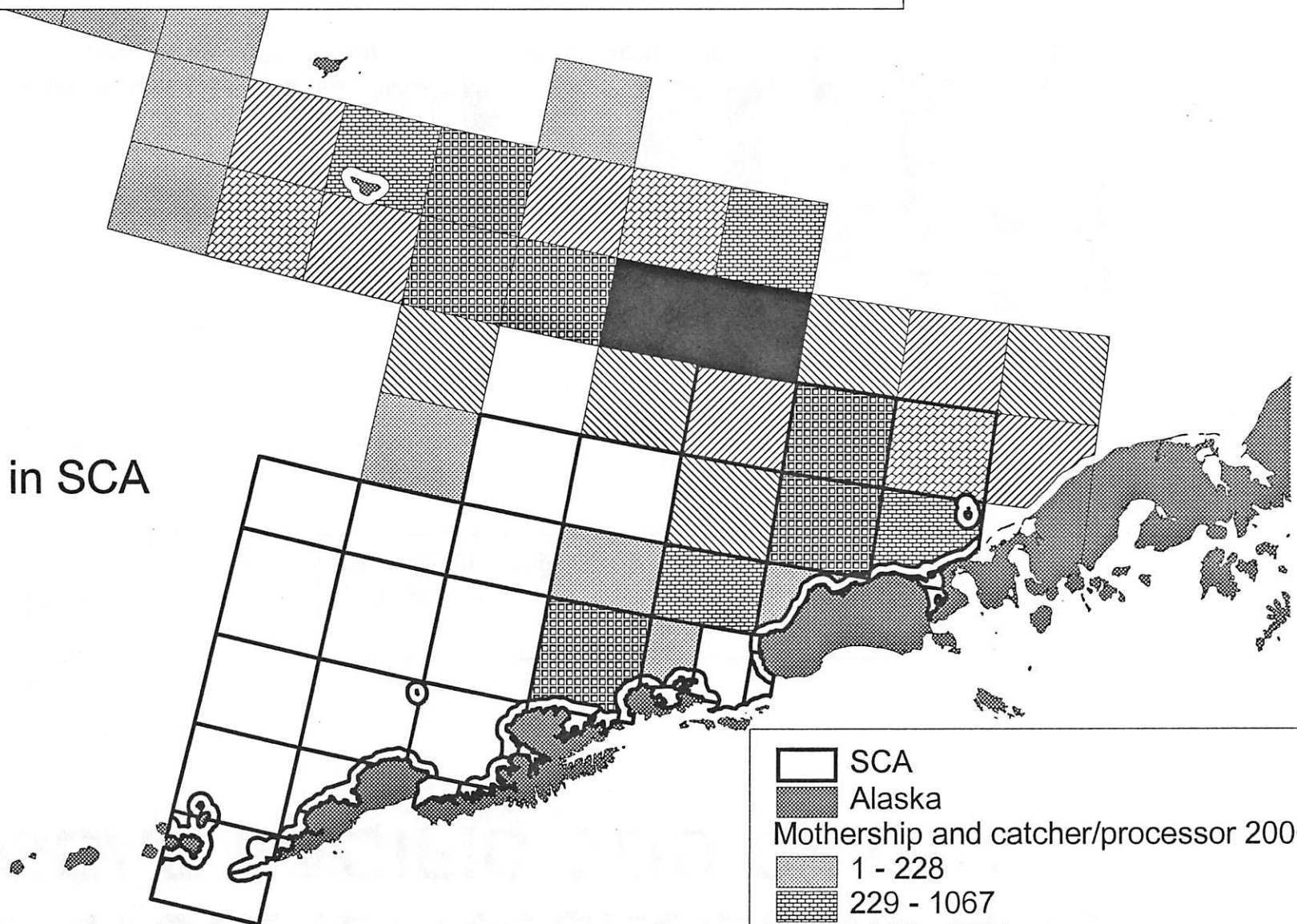

2000 BSAI CATCHER VESSELS & CATCHER/PROCESSORS TRW GEAR PACIFIC COD CATCH

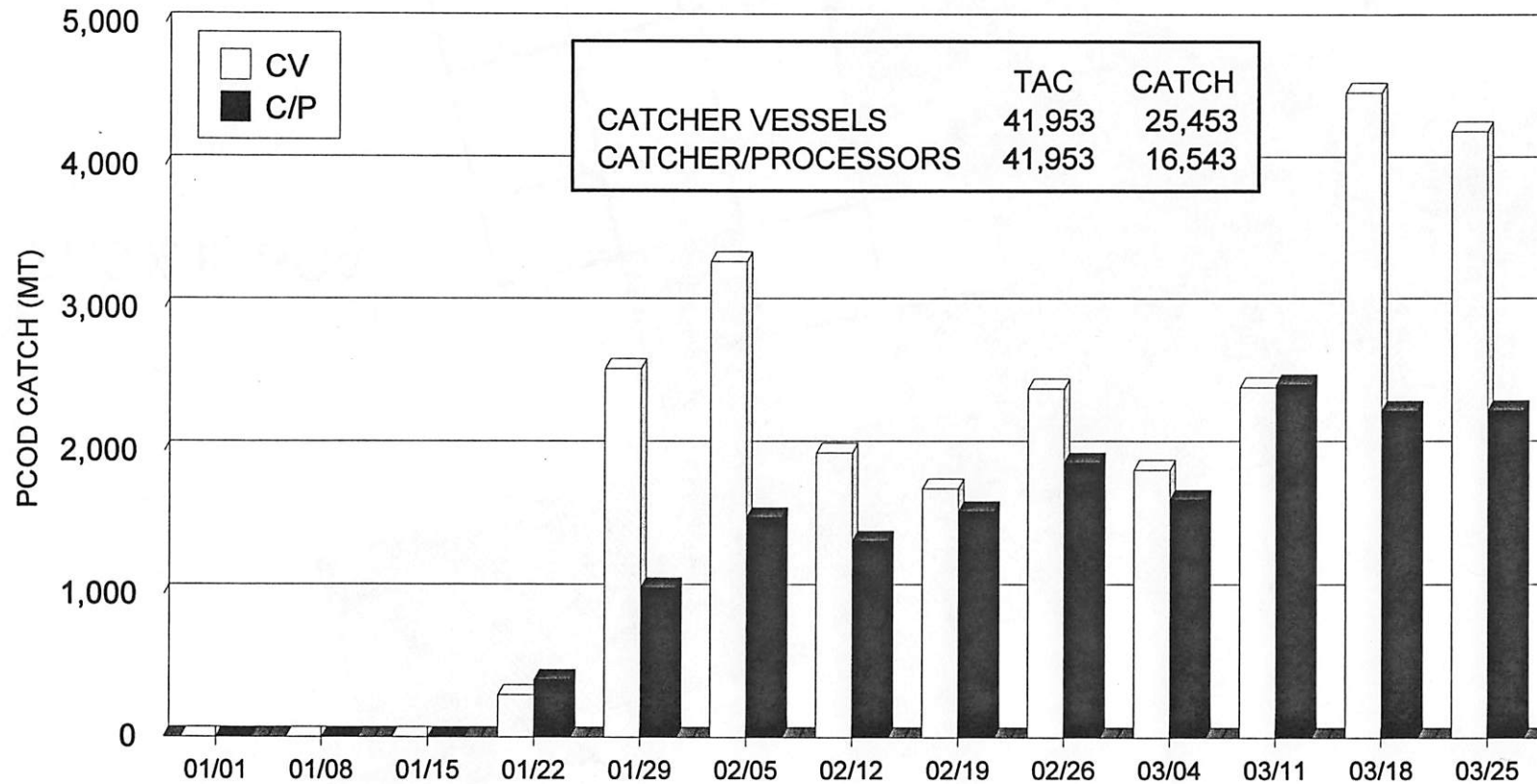

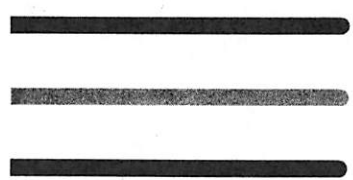

2000 BSAI 'A' SEASON TRAWL ATKA MACKEREL FISHERY (sheet 1 of 2)

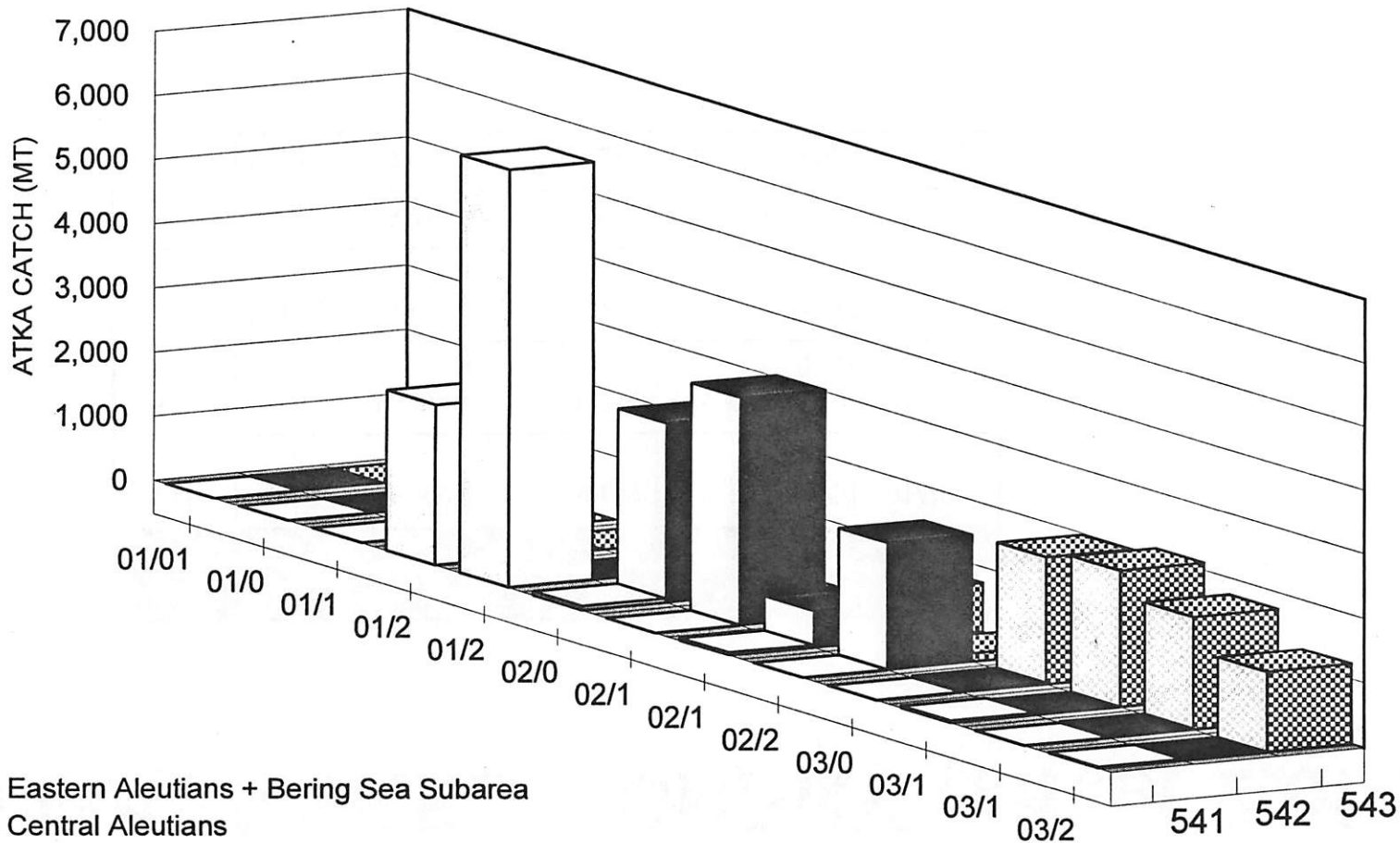

541 = Eastern Aleutians + Bering Sea Subarea
542 = Central Aleutians
543 = Western Aleutians
CH = Critical habitat
Out CH = outside critical habitat

2000 BSAI 'A' SEASON TRAWL ATKA MACKEREL FISHERY (sheet 2 of 2)

AREA	'A' SEASON TAC	CATCH (MT)	CLOSED
541	7,509	9,199	Out, CH 01/01 - 01/20 01/29
542	11,424	8,940	Out, CH 01/01 - 01/20 02/26 - 04/03
	CH Limit 7,654	6,752	CH 02/10 - 02/23 04/03
543	13,736	7,957	Out, CH 01/01 - 01/20
	CH Limit 7,829	7,289	CH 03/22

541 = Eastern Aleutians + Bering Sea Subarea

542 = Central Aleutians

543 = Western Aleutians

CH = Critical habitat

Out CH = outside critical habitat

2000 BSAI TRW GROUND FISH CATCH & HALIBUT MORTALITY

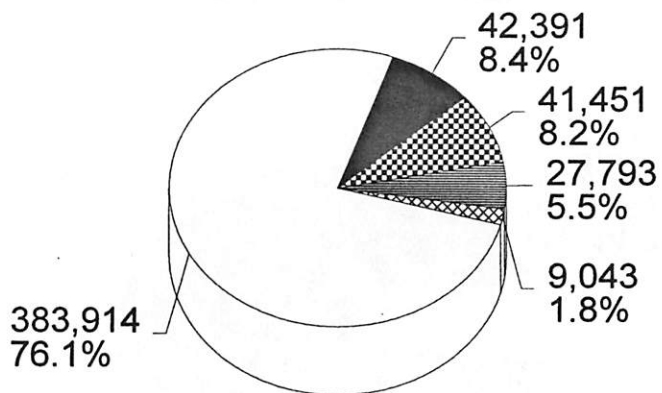

GROUND FISH (MT)

Total: 504,592

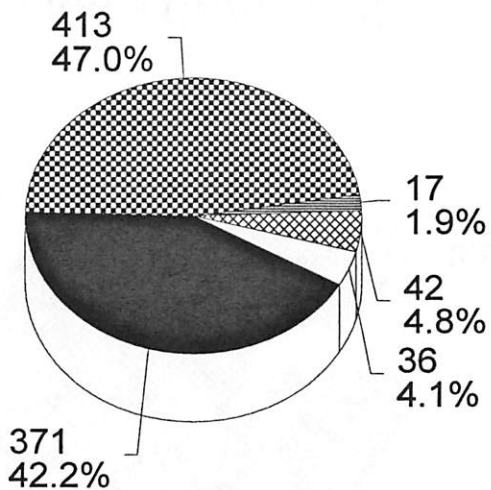

HALIBUT MORTALITY (MT)

Total: 879



PCOD = Pacific cod
 YFIN = yellowfin sole
 MXD = rock sole, flathead sole, and "other flatfish"
 PLCK = pollock, Atka mackerel, and "other species"
 ROCK = rockfish
 ARRW = Arrowtooth, sablefish, and Greenland turbot

MXD closed 3/4 to 4/1
 due to halibut
 mortality restrictions

2000 ZONE 1 BSAI TRW GROUND FISH CATCH & INCIDENTAL RED KING CRAB CATCH BY TARGET

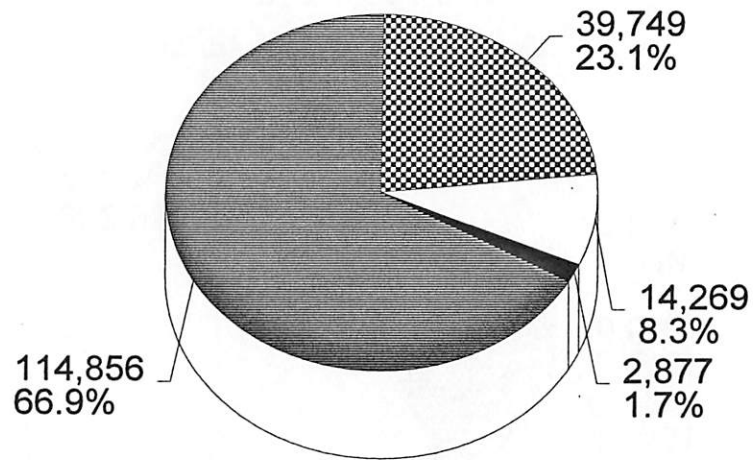

GROUND FISH (MT)
Total: 171,751

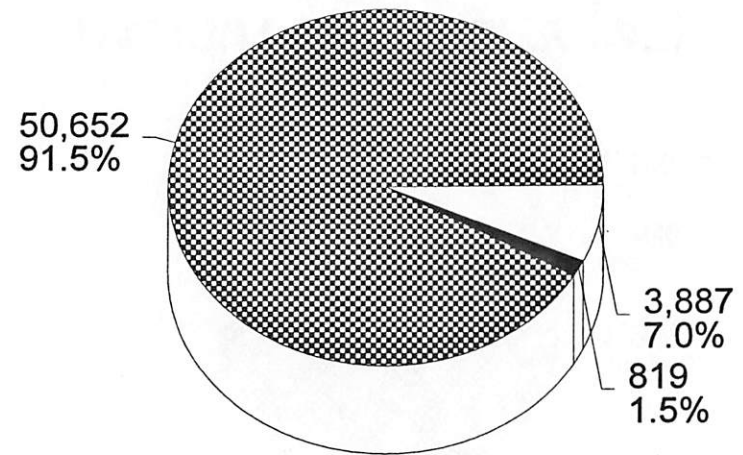

RED KING CRAB (NOS.)
Total: 55,358



PCOD = Pacific cod
 YFIN = yellowfin sole
 MXD = rock sole, flathead sole, and "other flatfish"
 PLCK = pollock, Atka mackerel, and "other species"

2000 ZONE 1 BSAI TRW GROUND FISH CATCH & INCIDENTAL BAIRDI TANNER CRAB CATCH BY TARGET

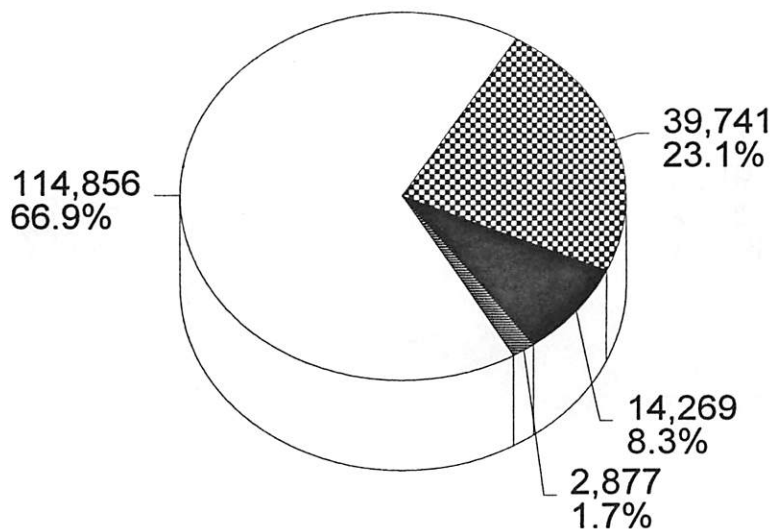

GROUND FISH (MT)

Total: 171,743

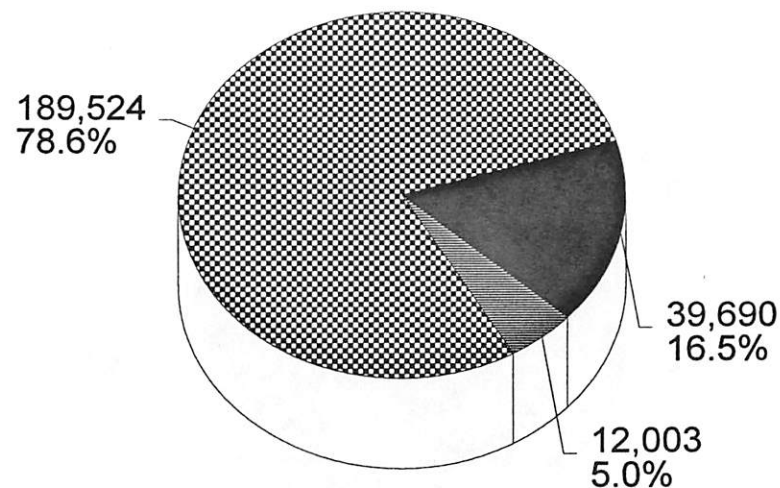

BAIRDI CRAB (NOS.)

Total: 241,217



PCOD = Pacific cod
 YFIN = yellowfin sole
 MXD = rock sole, flathead sole, and "other flatfish"
 PLCK = pollock, Atka mackerel, and "other species"

2000 ZONE 2 BSAI TRW GROUND FISH CATCH & INCIDENTAL BAIRDI TANNER CRAB CATCH BY TARGET

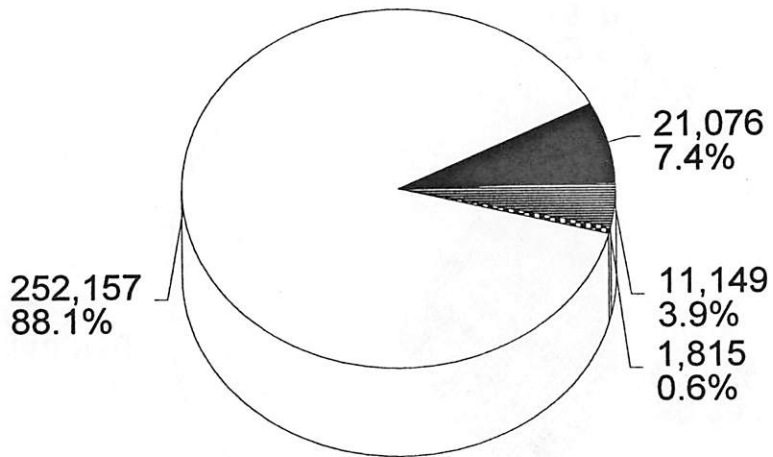

GROUND FISH (MT)
Total: 286,197

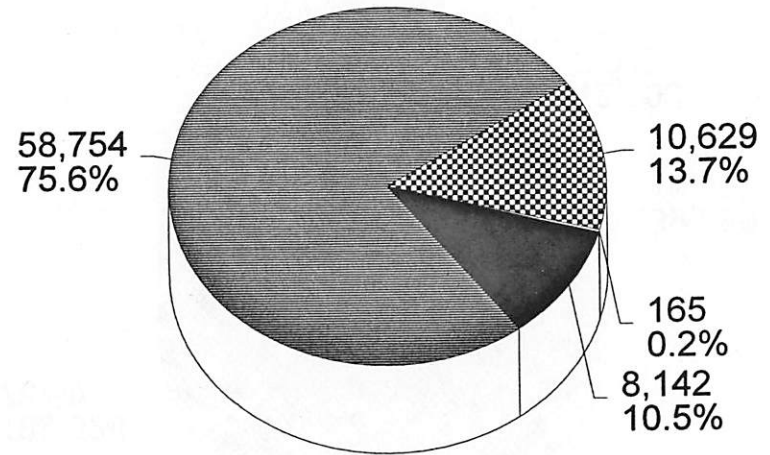

BAIRDI CRAB (NOS.)
Total: 77,690



PCOD = Pacific cod
 YFIN = yellowfin sole
 MXD = rock sole, flathead sole, and "other flatfish"
 PLCK = pollock, Atka mackerel, and "other species"