C4 BBRKC: GROUNDFISH AREA CLOSURES

SAM CUNNINGHAM & MASON SMITH, JUNE 2023



PRESENTATION OUTLINE

- Purpose & Need; Alternatives (Sections 1, 2)
- Fishery background information assembled (Section 3)
- Environmental information incl. target groundfish species, BBRKC, and habitat (Section 6)
- Spatial PSC rate information RE: effort relocation (Appendix 2)
- Discussion of alternatives/impacts (Section 5)
- Pelagic gear definition and “trawl gear performance standard” (Section 4)



PURPOSE & NEED

- Low BBRKC stock & recruitment; projected biomass decline due to a “combination of factors”; consecutive directed fishery closures
- “Council intends to consider mgmt. measures focused on reducing BBRKC mortality from groundfish fishing in areas that may be important to BBRKC and where BBRKC may be found year-round”
- “May help increase” stock abundance and promote OY in BBRKC fishery... while “minimizing negative impacts on affected groundfish operations as well as target and PSC species”

EA section on BBRKC describes available information on fishing & environmental factors affecting the stock

- EFH/fishing effects
- 2022 stock assessment/ESP & AFSC 2022 statement on ecosystem-based data



MANAGEMENT AREA

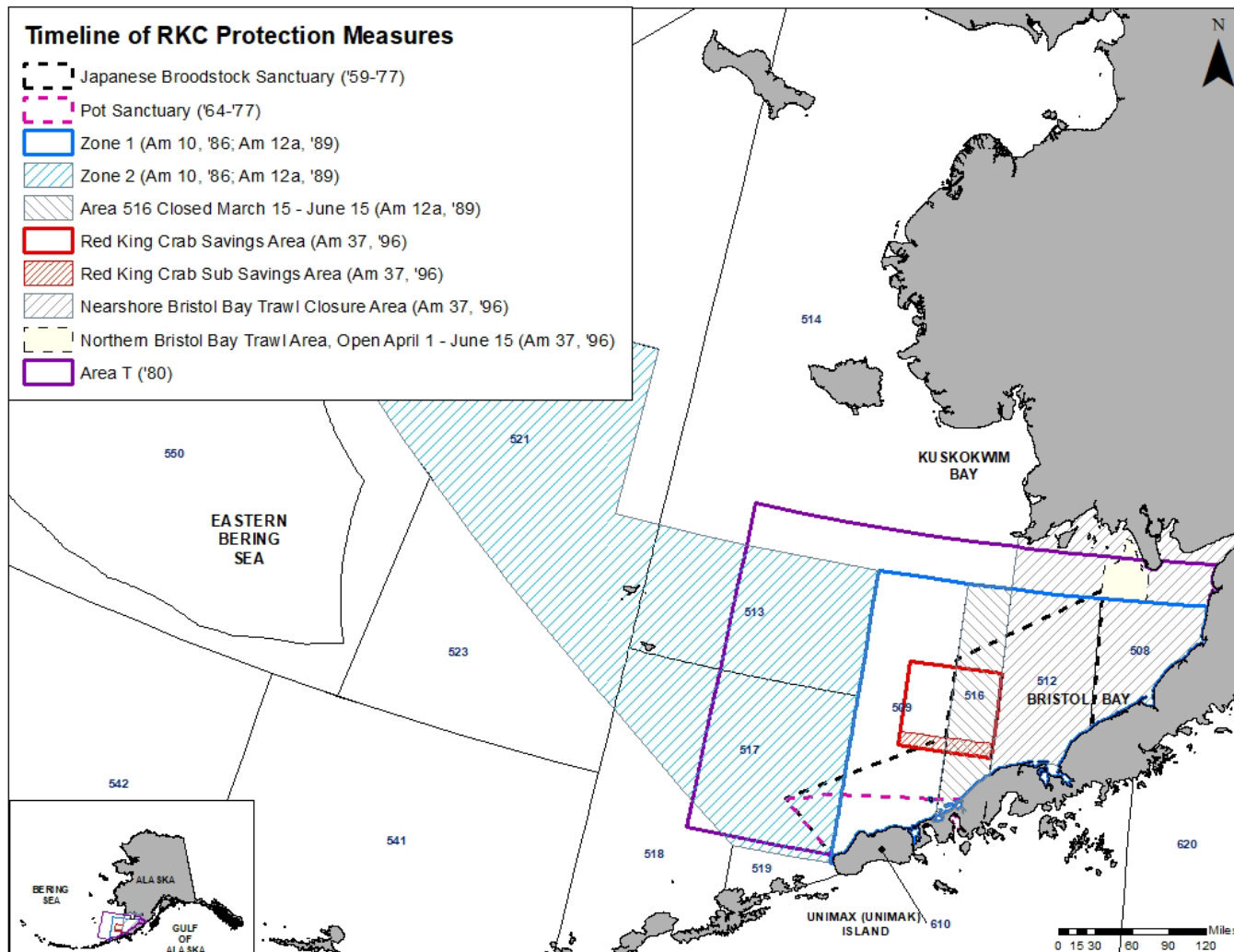

ALTERNATIVES

Alt. 1: No Action

Alt. 2: Annual closure of RKCSA/SS to all commercial groundfish gears (i.e., PTR, NPT, POT, HAL)

Trigger

Option 1: Closure in effect if ADF&G did not establish a TAC for the BBRKC directed fishery in the preceding year

Option 2: Closure in effect if total area-swept biomass for BBRKC is less than 50,000 mt (most recent EBS trawl survey)

Suboptions (apply to Alt. 2 regardless of Option selected):

Extent

Sub. 1: Exempt HAL gear (→ RKCSA closed to PTR, NPT, POT)

Sub. 2: Exempt POT gear (→ RKCSA closed to PTR, NPT, HAL)

Alt. 3: Annual closure of NMFS Area 512 to Pacific cod pot fishing

Must select either Option 1 or 2 as an annual trigger



CLARIFICATION RE: ALT. 2

- Reference to RKCSS – “existing closure for NPT gear is not changed” – was made for emphasis/clarity. If Alt. 2 is selected, RKCSS would only be open to NPT if conditions of Alt. 2 are met and the BBRKC directed fishery was open in the previous year. Also, NPT is still limited to using no more than 25% of its Zone 1 RKC PSC limit in the RKCSS.
- Area-swept estimates (re: Option 2) are not the same as the length-based analysis (LBA) estimates that feed into the State’s BBRKC harvest strategy. Thus, it is possible that “area-swept < 50k” while the BBRKC fishery was not closed. Also, Federal rules (Crab FMP) to close the BBRKC fishery by not setting an ABC are based on male crab abundance (diff. than “total”, and male/female proportions differ year-to-year).

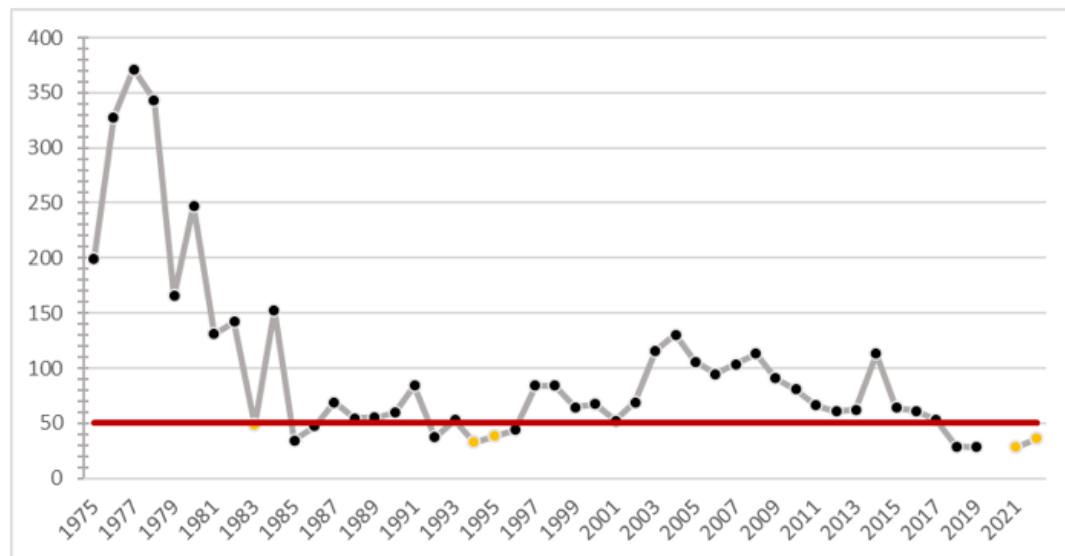

Figure 2-1 Total survey biomass “area-swept” estimate (mt), 1975-2022; survey years preceding a BBRKC directed fishery closure are highlighted in orange (Data source: Palof & Siddeek 2022, Table 9a)



FISHERY BACKGROUND (SEC. 3)

- “Affected groundfish fisheries” organized as Pelagic Trawl, Non-Pelagic Trawl, PCod Pot, and PCod HAL
 - History & description of participation
 - Limitations on timing/location of fishing under existing regulations and fishery practices (**Section 3.1 for PTR and NPT**)
- Catch (groundfish basis weight) and bycatch by gear, area and seasonality; area-breakouts include RKCSA, Area T, “Other Area T”, Zone 1, and Bering Sea (Sec. 3.2). Area 512 data is provided as specific to Pacific cod pot fishery.
- For each “fishery” (gear), five years of vessel count and gross revenue (2018-22) provided as first-wholesale (CP) or ex-vessel (CV) in 2022\$
 - Comparing RKCSA to BS FMP Area



FISHERY BACKGROUND (SEC. 3)

- Pelagic Trawl
 - Reporting area-level proportions of salmon/herring bycatch in pollock fishery (2018-22) – **Table 3-15 (p.57)**
 - AFA participation off US west coast: vessel count and gross *ex-vessel* revenue. CP revenues estimated at *ex-vessel* level for methodological consistency across US regions (AKFIN)
- Non-Pelagic Trawl
 - Zone 1 RKC PSC limits (**Table 2-1, p.28**) ~ Zone 1 RKC PSC estimates (**Table 3-4, p.52**) ... For 2010-2022, lower PSC limit regime would have resulted in PSC closures in most years for A80, 3 years for CDQ, and 1 year for TLAS PCod
- PCod Pots
 - Cross-participation in Pacific cod and Crab (**Figure 3-7, p.46**)
 - RKCSA shift toward O60 CVs; RKCSA effort reduced in recent years
 - Area 512 participation (CV) increase since 2019 (**Figure 3-9, p.47**)
 - Tendering in Area 512 (**Section 3.2.3.1; Table 3-23/24, p.63**). Deliveries to tenders dominating in 512 and stand out relative to other areas.
 - **Table 3-20 (p.61)** shows that Areas 509/16 and 512 rank high in terms of total cod catch and RKC presence in catch composition (esp. 512)... metric is in tons



FISHERY BACKGROUND (SEC. 3)

Community ties, processing, and LKTKS

- Community/processing information built around “SIA-type” data tables; do not include A80/TLAS NPT data in this iteration. Council has recently reviewed A80 SIA and TLAS has generally not fished in the RKCSA. This information could be added as required.
- Revenue & dependency tables for inshore processing is reported as wholesale values converted algorithmically from ex-vessel estimates, per request of the SSC/Council (**new**)
- Broadly, analysts presume that recent historical participation within the RKCSA (across gear types) is an adequate reflection of the near future. Participation in Area 512 (Pot Cod) has shown more variation relative to longer-term trend.
- Document does not include local tax revenue analysis. Basic rationale is that state-level fishery utilization (gross revenue) will be maintained within margin of annual variation. Areas/communities “of interest” re: Area 512/Alt.3 can only be presented qualitatively, but more information can be added about (un)incorporated status and how that affects whether tax revenue flows to borough or locality.



FISHERY BACKGROUND (SEC. 3)

Community ties, processing, and LKTKS

- Examples of information in tables:
 - Vessels in RKCSA or 512 by CV/CP, and community link
 - Revenue from that area (or pot cod fishery) compared to all Alaska areas fished by the vessels swept up in that data query (RKCSA and/or 512)
 - Relative weight of revenues coming into a community from fishing in RKCSA or 512 relative to all harvesting/processing activity linked to those same communities
- LKTKS (3.4)
 - No returns in the developing [LKTKS search engine](#) for BBRKC, BS pollock, or BS Pacific cod
 - “Skipper Survey” (ABSC) for BBRKC last took place in pilot phase in 2020 and has not yet been conducted during an active year, nor reviewed for systematic data collection (contrast to BS snow crab)
 - Most recent comprehensive ADF&G review of subsistence fishing in BB region was Holen & Lemons 2012 (generally targeted for 10-yr frequency); 6 community level surveys within the BB region are in progress or near to beginning
 - ADF&G advises that comprehensive surveys does not represent variation in harvest use across communities and households as well as community-level surveys – esp. for low harvest level species like RKC
 - Looked at CSIS data for crab and PCod, finding low levels of subsistence in certain communities *by pounds* but not generalizable



FISHERY BACKGROUND – BBRKC (3.5)

- The most recent Crab Economic SAFE states that, as a result of 2 years of BBRKC fishery closure and a simultaneous closure of Bering Sea snow crab in the most recent year, *“the BSAI crab industry, dependent communities, and other stakeholders currently face the prospect of a prolonged period of income and employment loss as a result of trends and closures in these and other crab fisheries. The scope and scale of structural changes within the crab industry and extended community that may ultimately be precipitated by the immediate crisis are unknown and difficult to anticipate with any clarity”*
- Document provides “scope and scale” of the fishery since rationalization (**Table 3-54, p.81**), community engagement through ACEPO (data through 2021), and fishery valuations from recent Federal fishery disaster declarations
 - Disaster declaration valuations are based on 5-year average ex-vessel value estimates; thus, they do not account for value added at processed stage or other losses in linked or cumulative economic production.
- 2017-2020 data on BBRKC active vessels, crew positions, crew compensation, captain shares, and community engagement (via ACEPO)
- CR Program 10-yr Review (NPFMC 2017) notes high linkage to other crab fisheries (snow, tanner) and PCod. Ability of a crab-focused vessel to continue participation relies on a suite of species that are different in terms of volume and value/lb.



ENVIRONMENTAL INFORMATION (SEC. 6)

- Section covers four target groundfish species, BBRKC, seabirds, and habitat
- Groundfish – pollock, PCod, YFS, and rock sole – cover species most targeted in/around RKCSA and NMFS 512
- SSC may weigh in on other information or resource components necessary to understand the “affected environment”.
- Document mainly considers effect of action alts. as spatial/temporal changes in effort. Those changes are constrained by seasonal TAC apportionments and existing annual/seasonal closures for certain sectors.
- Spatial redistribution effects might be obvious in terms of gear/footprint/habitat (as understood through the cumulative FE model), or less obvious if there is an underlying change in the total amount of effort deployed (primarily regarding trawl). Relative to No Action, the Council could consider whether presumed benefit to BBRKC/habitat is likely to outweigh possibility that a less efficient groundfish fishery will impact marginally more grounds and more non-crab non-target species as a result of area closures. Presumed benefit to BBRKC stock is an important unquantified unknown in this analysis – best available information on efforts to improve that base of information is in Section 6.3.
- Interannual variability in spatial/temporal effort already exists across all involved gears
 - Environmental conditions, target species aggregation, market size, comingling with PSC/non-target GF
 - Maximum spatial/temporal footprint constrained by existing limits on participation, areas, resource availability, and fishing/processing logistics



ENV. CONTEXT – BBRKC (SEC. 6.3)

- Molt/mate seasonality (shown relative to groundfish in **Fig 3-1, p.35**)
- Survey distributions (female/male) and crab fishery effort in **Figs 6-3 to 6-6 (pp.117-120)**
- Ongoing research (NMFS/ADFG/BSFRF) – Section 6.3.1
 - History of effort to fill data/knowledge gaps since 2017
 - Recently fielded pot survey results (winter/spring 2023, **Figs 6-7/8, pp.123-24**) should not be used for conclusions about sex distribution at least until there is a chance to compare that single year of pot sampling to the 2023 EBS trawl survey
- Groundfish predation on BBRKC (Sec. 6.3.2) – reviewed Oct. 2022
- Effects (Sec. 6.3.3)
 - Redistribution of groundfish pot effort east or west of RKCSA could be dictated by Selection of Alt 2 vs. Alts 2+3
 - Reduction in unobserved direct trawl mortality is a presumed benefit but not quantifiable; habitat impacts considered in terms of FE model
 - Effect of predator/prey dynamics for PCod are understood but net direction relative to Alt. 1 is not quantified; BB sockeye predation data is a potentially important data gap
 - Displacing groundfish effort away from “core” stock area has *prima facie* benefits, with heavy caveats about the relative weight of direct fishing mortality and the fact that estimated RKC bycatch in groundfish fisheries is already incorporated in the BBRKC stock assessment.



ENV. CONTEXT – HABITAT (SEC. 6.5)

- EFH, Fishing Effects, and seafloor contact (APU product from Dec. 2022)
- EFH shows the relative importance of the BB region to RKC; FE shows cumulative effects mainly in the SW quadrant of the RCKSA and westward or south, closer to Unalaska/SCA; seafloor contact (**Fig 6-15, pp.140-41**) shows A/B seasonality.
- Presumptive redistribution of effort under action alternatives moves mobile gear away from key BBRKC habitat areas
- Gross volume of mobile gear effort is presumed similar to recent history. Reduction is possible but unlikely (fishery less viable). Increase through less effective targeting of groundfish could increase habitat impacts but the location of that effort relative to key RKC habitat is unknown. Likely west or south of RKCSA, with some areas southwest of RKCSA having been considered important habitat areas at points in the past.



PSC DISPLACEMENT (APPENDIX 2)

- Gives an idea of changes in PSC for affected species
 - Chinook, non-chinook, herring, halibut, BBRKC, Opilio, and Bairdi
- Dec 2022: Council suggested mapping PSC displacement over a range of years/seasons
 - Annual estimates (2020-2022) chosen to represent the Council motion
- Displacement to: adjacent area (orange), area of high PSC in the SCA (yellow), and an area of highest PSC rates (green) of equal size to the displaced area

$$\text{Est. Increase} = [(RKCSA \text{ GF catch}) * (\text{avg PSC rate})] - RKCSA \text{ PSC}$$

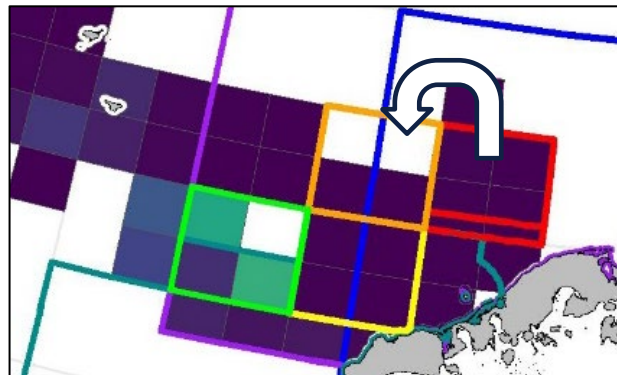

PSC DISPLACEMENT: CHINOOK (PTR)

Annual (2020) Chinook Salmon PSC Rate (PTR)

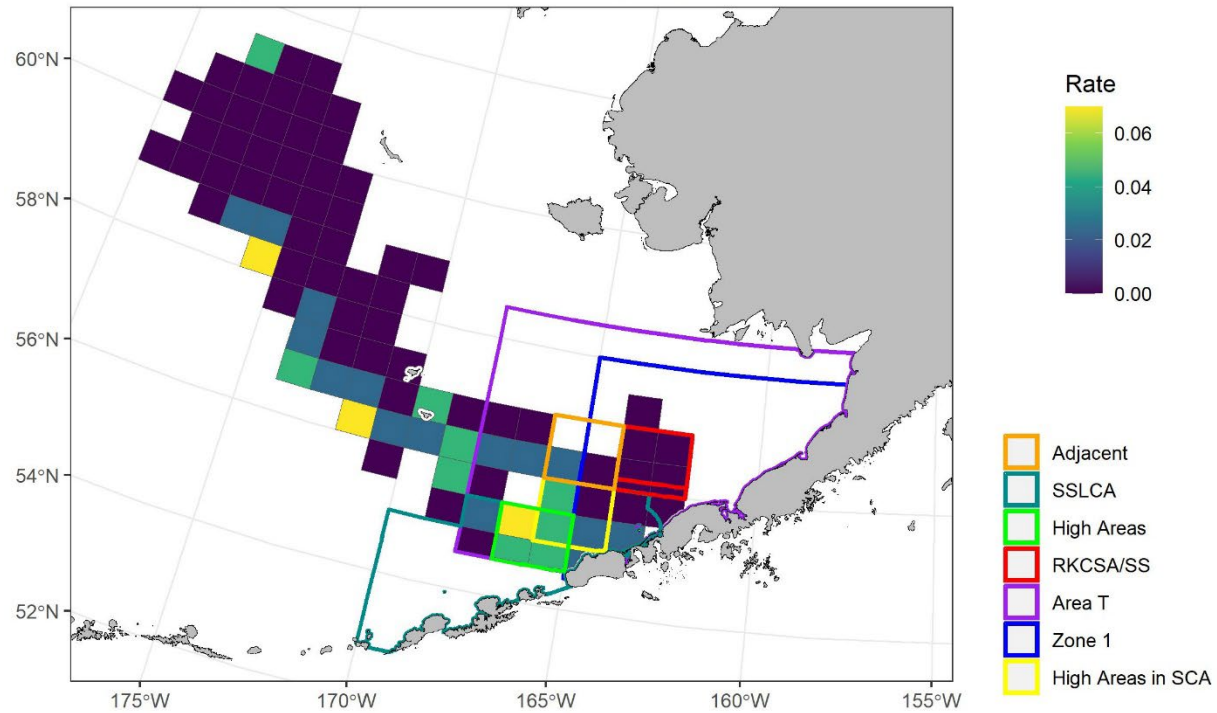

YEAR	AREA	Chinook_PSC	Sum_GF_mt	rate	est_increase
2020	RKCSA/SS	178	27,520	0.006	0
	Adjacent	657	30,037	0.022	424
	High Area	4,982	120,033	0.042	964
	SCA	8,045	233,677	0.034	769



PSC DISPLACEMENT: CHINOOK (PTR)

Annual (2021) Chinook Salmon PSC Rate (PTR)

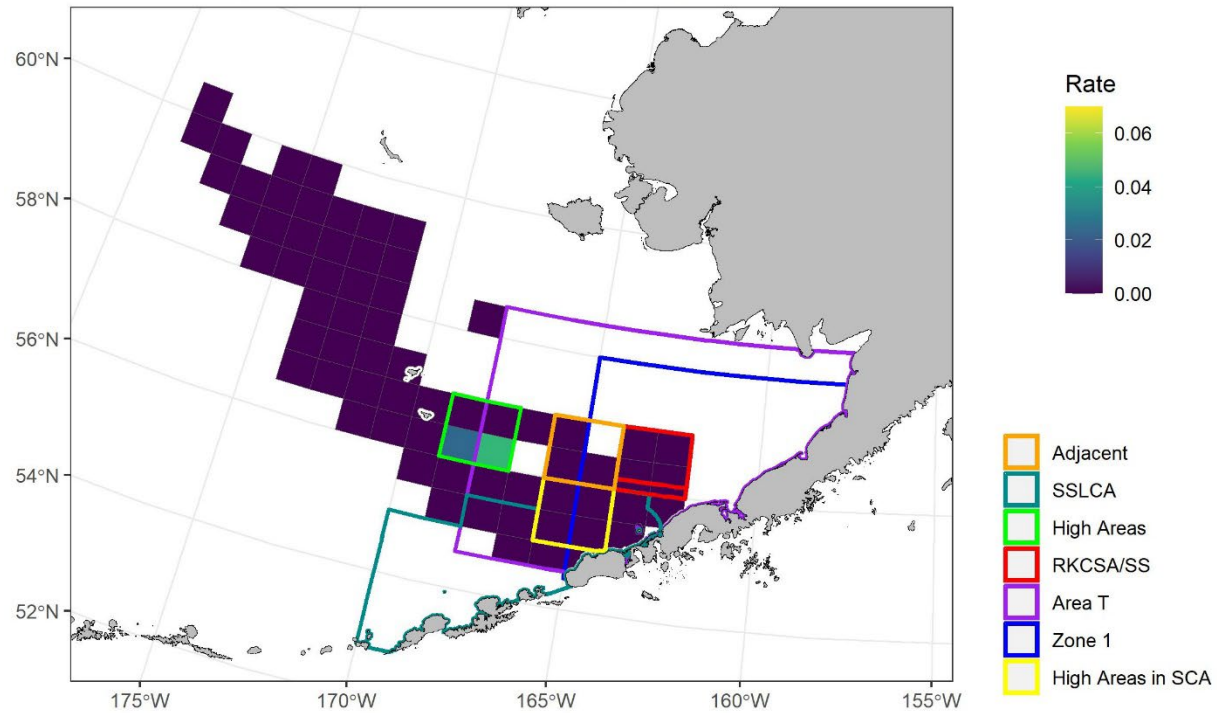

YEAR	AREA	Chinook_PSC	Sum_GF_mt	rate	est_increase
2021	RKCSA/SS	562	74,913	0.008	0
	Adjacent	105	10,046	0.010	221
	High Area	2,218	95,479	0.023	1,178
	SCA	4,180	284,661	0.015	538



PSC DISPLACEMENT: CHINOOK (PTR)

Annual (2022) Chinook Salmon PSC Rate (PTR)

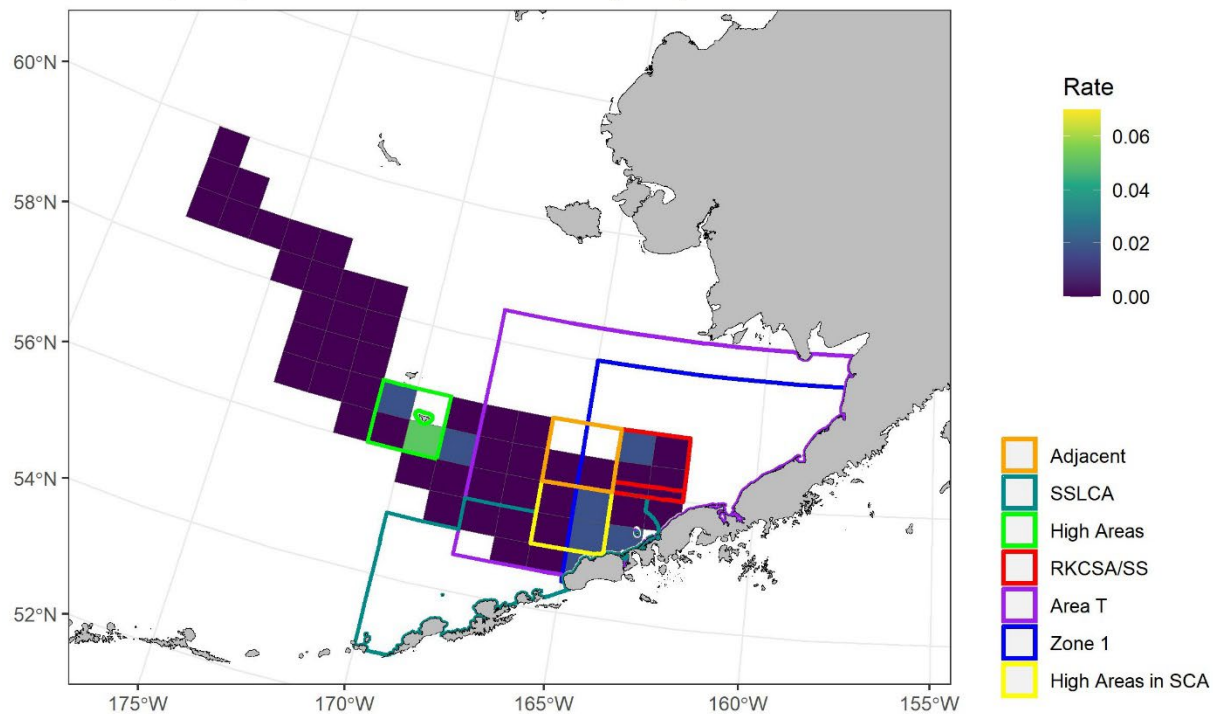

YEAR	AREA	Chinook_PSC	Sum_GF_mt	rate	est_increase
2022	RKCSA/SS	589	111,954	0.005	0
	Adjacent	429	85,612	0.005	-28
	High Area	189	12,985	0.015	1,040
	SCA	3,172	278,105	0.011	688



PSC DISPLACEMENT: RKC (POT)

Annual (2020) Red King Crab PSC Rate (POT)

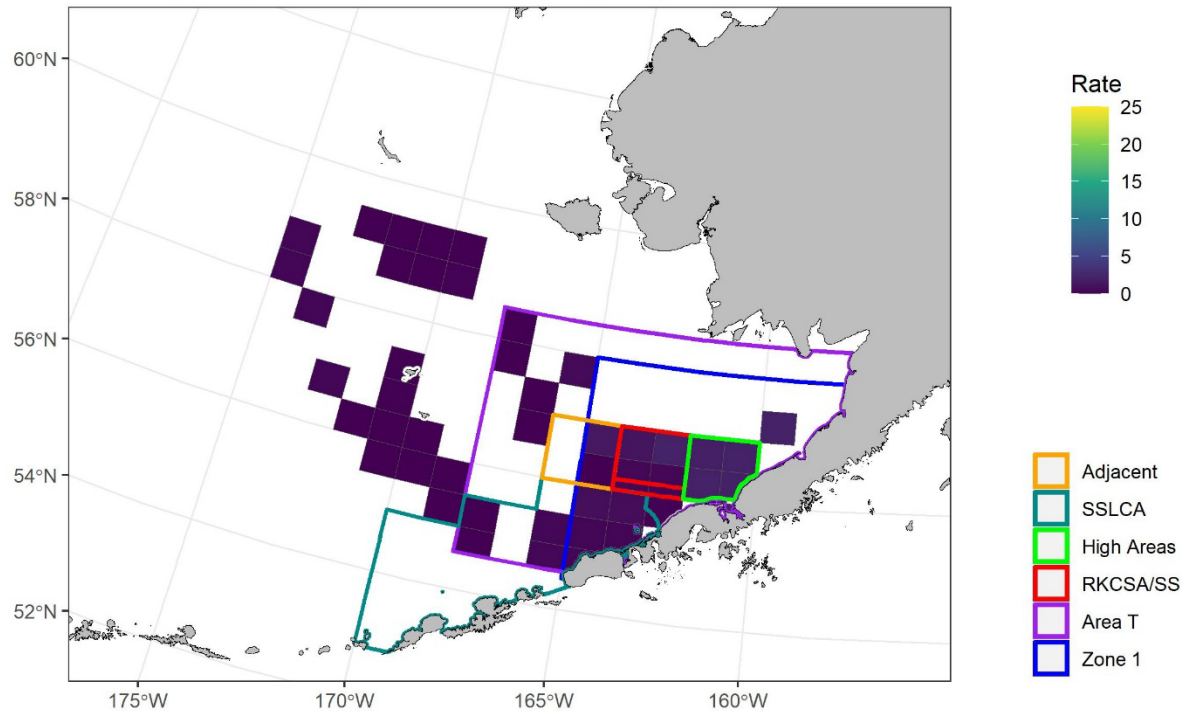

YEAR	AREA	RKC_PSC	Sum_GF_mt	rate	est_increase
2020	RKCSA/SS	984	2,320	0.424	0
	Adjacent	42	163	0.257	-387
	High Area	7,971	4,160	1.916	3,462



PSC DISPLACEMENT: RKC (POT)

Annual (2021) Red King Crab PSC Rate (POT)

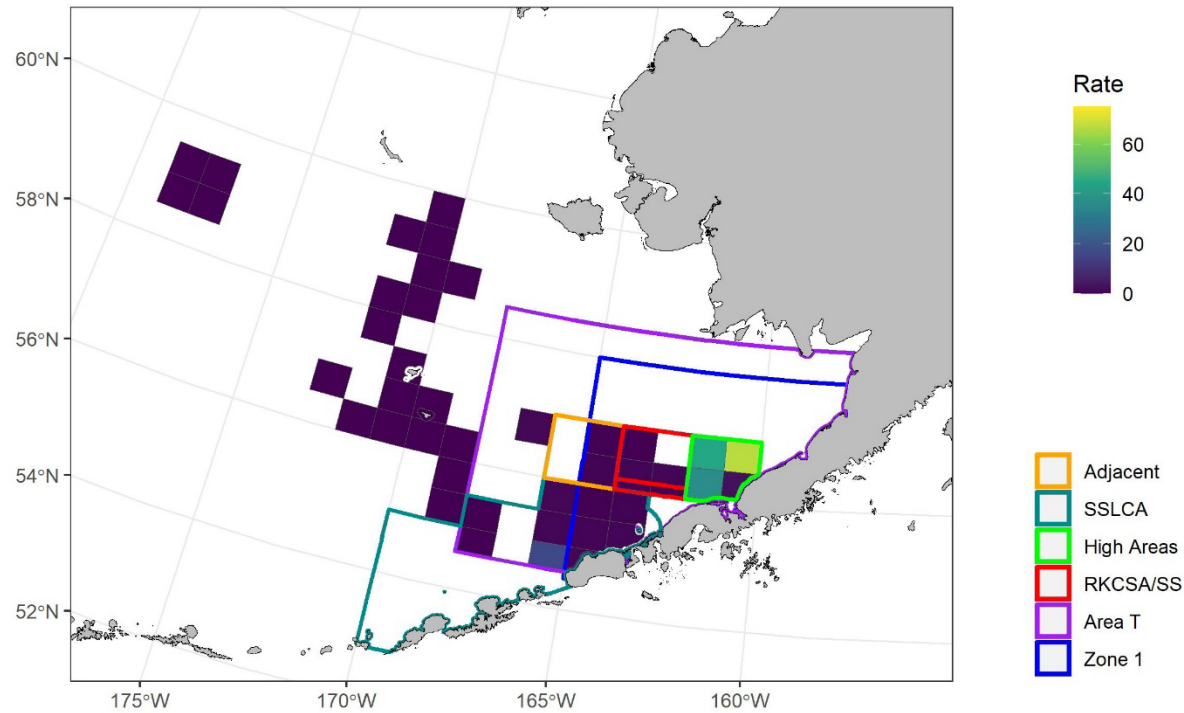

YEAR	AREA	RKC_PSC	Sum_GF_mt	rate	est_increase
2021	RKCSA/SS	303	443	0.684	0
	Adjacent	94	223	0.419	-117
	High Area	218,101	4,388	49.705	21,702



PSC DISPLACEMENT: RKC (POT)

Annual (2022) Red King Crab PSC Rate (POT)

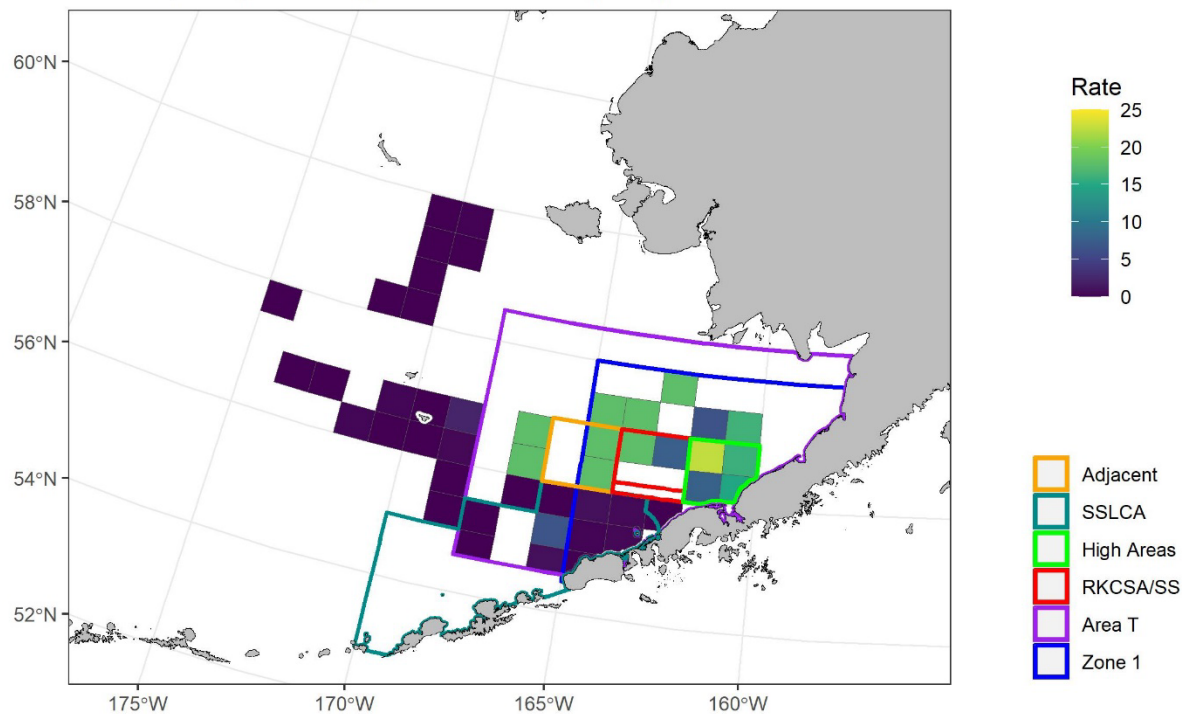

YEAR	AREA	RKC_PSC	Sum_GF_mt	rate	est_increase
2022	RKCSA/SS	4,280	470	9.114	0
	Adjacent	394	22	17.775	4,067
	High Area	79,273	4,381	18.097	4,218



PSC DISPLACEMENT (APPENDIX 2)

- Maximum (worst-case scenario) increases:

Group	Max. increase	% increase of Area T PSC
Chinook	964 to 1,178	5-19%
Non-chinook	33,209 to 237,586	44-74%
BBRKC	3,462 to 21,702	8-51%

- Displaced areas of high non-chinook & BBRKC PSC rates consistent
 - Good for PSC avoidance measures
- Movement of pot gear into 512 resulted in highest BBRKC PSC
- Limited by mismatch in seasonal groundfish effort and PSC rates
 - Negligible B season PTR landings in the RKCSA when non-chinook PSC rates were very high, so these numbers would likely be much lower in reality
 - Future analysis to split seasonally



DISCUSSION OF ALTERNATIVES/IMPACTS (SEC. 5)

- Relative to No Action, assessing the action alternatives requires the Council to weigh adverse impacts on groundfish fisheries against potential benefits to BBRKC
 - Impacts to GF are easier to point to...
 - e.g., revenue at risk; optionality; efficiency loss; cost to labor; cumulative effect of multiple GF fisheries becoming more constrained and less productive
 - ... but not necessarily easy to pin down the frequency and magnitude of those impacts on a fishery-by-fishery basis
 - i.e., assume that area closure will be in effect most/every year; new area closure is just one piece in a complex puzzle of how successful a sector/company/vessel will be in its annual fishing plan
 - Other factors: “Was the RKCSA/SS important to that sector/vessel that year? Why/why not?”
 - Benefits to BBRKC are easy to envision but difficult to quantify and more difficult to “prove”
 - Direct benefits (bycatch): Where does GF effort shift? How big an issue is unobserved mortality? Are DMRs as good as they can be? What is the relationship between gear presence and mortality? Crab movement.
 - Indirect benefits (habitat): Questions outstanding about RKC life history. Is the RKCSA a valuable area to protect? Is it the most valuable? What about inshore areas (no trawl)? What about areas south and west of RKCSA that were thought of as core habitat decades ago?



DISCUSSION OF ALTERNATIVES/IMPACTS (SEC. 5)

- “Revenue at risk” represents a maximum (unlikely) impact. Not equivalent to “forgone revenue”
- PTR is the only gear “fishery” that has increased fishing in the RKCSA during the analyzed period... exemplifying balancing of target catch rates and avoiding other PSC-limited non-target species
- Pot cod (O60 CV) fishery is most likely to forgo revenue, esp. under paired Alts. 2&3. Spillover effort into state-waters fisheries unlikely.
- PTR, NPT, and HAL fisheries each experience operational risk related to the closure of RKCSA; most likely effects would occur in the A season
- Recovery of harvester revenue by switching to other fisheries is highly constrained by LLP/rationalization programs, the status of crab fisheries, and practicality (timing, location relative to processing markets)
- Impacts on shore-based plants in the high-volume processing communities are presumed negative but low magnitude relative to total historical revenues coming from the affected areas and assumption of some relocated effort



SECTION 4: PTR GEAR AND PERFORMANCE STD.

Evaluation of Pelagic Trawl Gear Definition and Performance Standard



HISTORY OF PELAGIC TRAWL GEAR DEFINITION

- **1987:** “A trawl on which neither the net nor the trawl doors (or other trawl-spreading device) operates in contact with the seabed, and which does not have attached to it protective devices, such as rollers or bobbins, that would make it suitable for fishing in contact with the seabed.”
- **1990:** Emergency Interim Rule (1990) modified definition to promote escape of halibut and crabs
 - Closures in bottom trawl (has rollers/bobbins) fisheries to reduce halibut PSC
 - Loophole allowed continued bottom fishing by removing bobbins or rollers, concern for halibut
 - (1) stretched mesh $\geq 1\text{-m}$ for 10 meshes, 12-in webbing spacing at fishing line, or (2) parallel line spacing $\geq 1\text{-m}$ for 10 meters, and no plastic discs, bobbins, rollers, or other chafe-protection on foot rope
 - *Removed details about contact with the seabed*

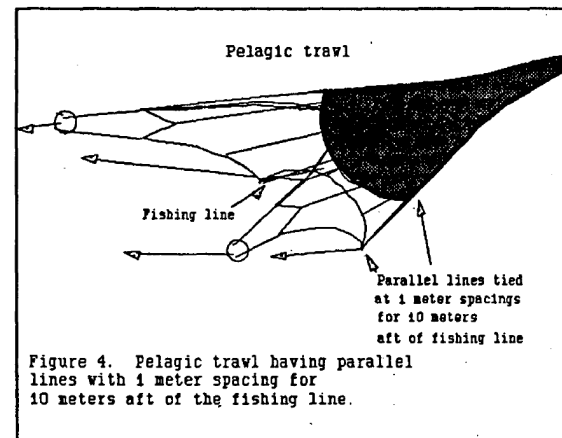
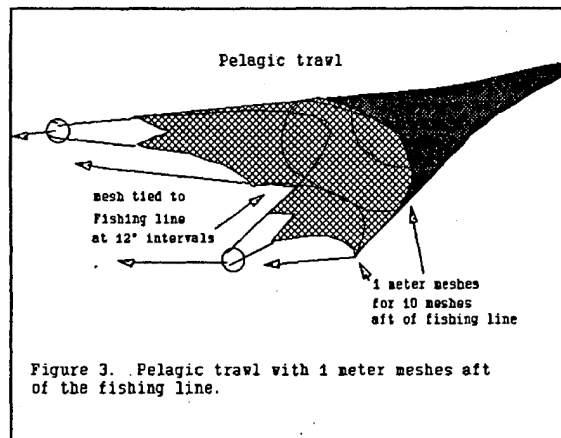

HISTORY OF PELAGIC TRAWL GEAR

- **1991:** FMP Amendments 16 & 21

- Suggested PTR should be defined as it is fished (not fished on the bottom, but may contact bottom at times), and maximize catch of groundfish, while **minimizing bycatch of halibut and crab.**
- EA: *“The purpose of the large mesh sizes in back of the fishing line is to provide escape panels for halibut and crab in case the pelagic trawl contacts or comes near the seabed”*

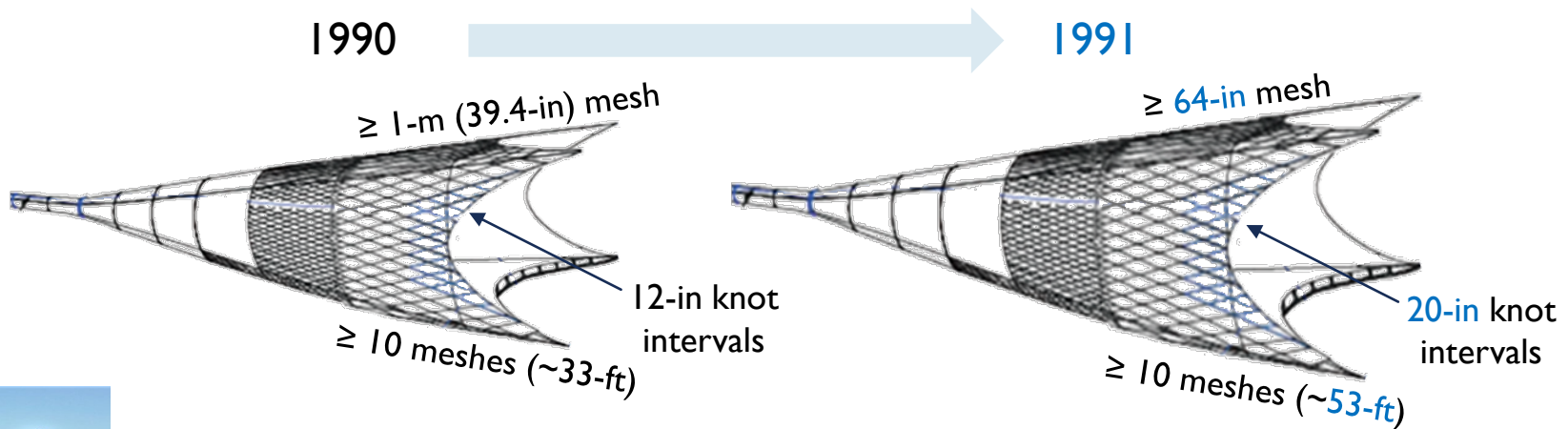

PELAGIC TRAWL GEAR

- **1991-1992:** Some fishermen continuing to modify and fish as non-pelagic gear
- **1993 (current):** regulatory definition of PTR refined, with objective to “*reduce halibut and trawl bycatches by discouraging or preventing trawl operations on the sea bed when halibut and crab PSC allowances have been reached.*”

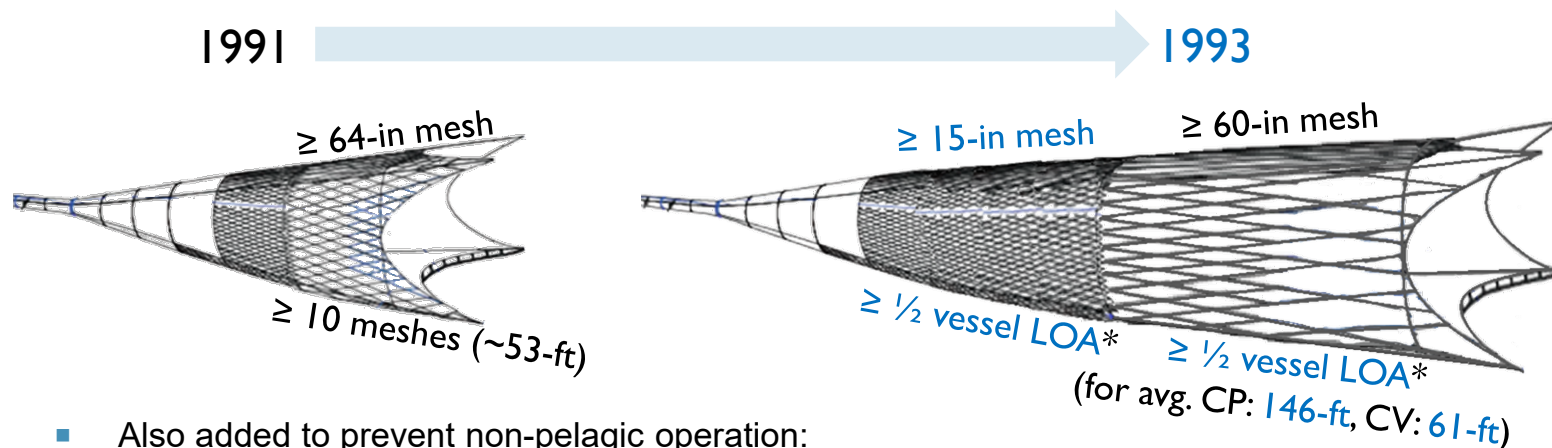

- Also added to prevent non-pelagic operation:
 - No floatation (except to 200-lb buoyance for net-sounder device), and no metal components forward of mesh $> 5.5\text{-in}$
 - No more than one fishing line and one footrope for a total of 2 weighted lines on the bottom of the trawl between the wing tip and fishing circle
 - Performance standard of no more than 20-crab onboard at any time



PELAGIC TRAWL GEAR

- Recent concern whether the codend is included in the definition of pelagic trawl gear
 - Current definition at 679.2: no flotation (except 200-lb buoyancy for net sounder device), and no metal components forward of mesh > 5.5-in
 - Definition of “codend” at 600.10: the terminal, closed end of a trawl net
 - Added in 1996 after pelagic trawl gear was defined
 - NMFS AKR does not believe the codend was intended to be included
 - Council may wish to clarify
 - Council may also consider revisions to allow for gear innovation (ex. Salmon excluder), and simplify compliance monitoring by removing outdated or inapplicable portions (e.g., parallel line trawls)



PERFORMANCE STANDARD

- To “*reduce halibut and trawl bycatches by discouraging or preventing trawl operations on the sea bed when halibut and crab PSC allowances have been reached.*”
 - Implemented as the *means* to discourage or prevent trawl operations on sea bed
 - Modified in 2001 to apply at all times
- 1991 observer data: as halibut bycatch doubled when > 20 crab caught, the Council considered > 20 crab as likely the result of operating a trawl on the sea bed

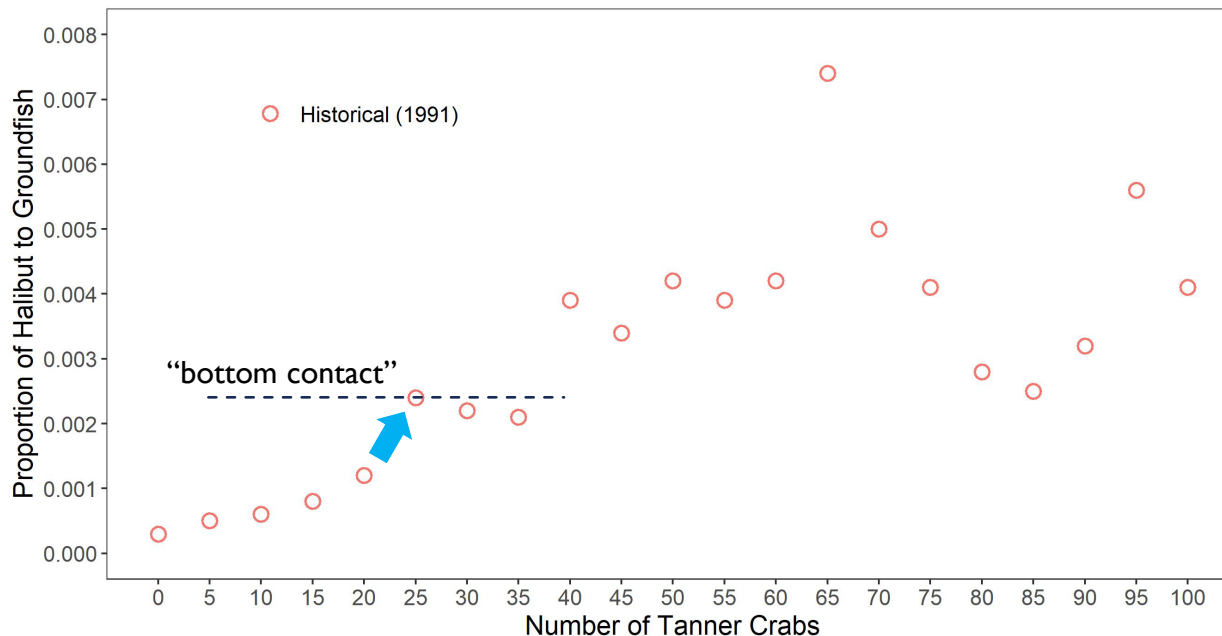

PERFORMANCE STANDARD

- Evaluation: Same analysis for recent years (2018-2022)
 - Substantially lower halibut bycatch rates

Halibut Bycatch: Historical (1991) vs Recent Average (2018-2022)



PERFORMANCE STANDARD

- Evaluation: Same analysis for recent years (2018-2022)
 - Substantially lower **crab** bycatch rates – percent of hauls catching zero crabs increased from ~78 to 99%

Tanner Crab per Haul: Historical (1991) vs Recent Average (2018-2022)

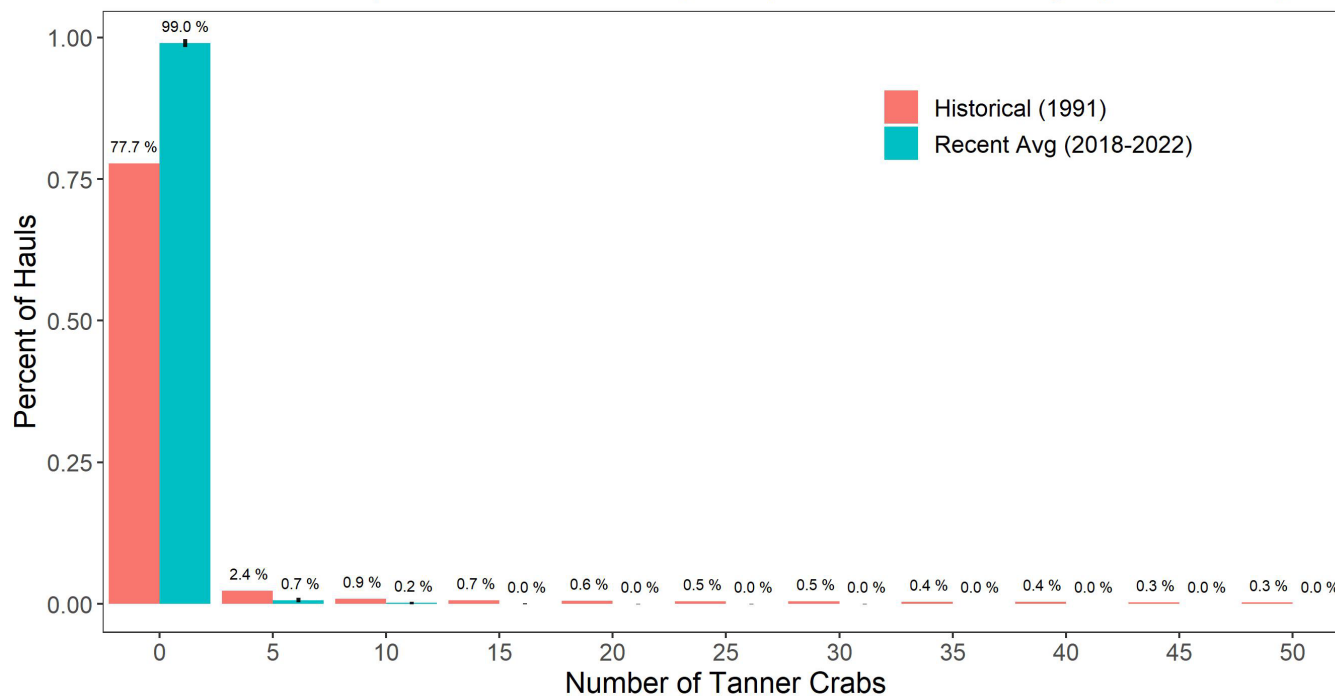

ARE COUNCIL OBJECTIVES MET?

- 1993 objective: “*reduce halibut and trawl bycatches by discouraging or preventing trawl operations on the sea bed when halibut and crab PSC allowances have been reached.*”
 - Successful in reducing halibut and crab bycatch through definition
 - Unlikely due to the discouraging or prevention of trawl operations on the sea bed
 - Likely due to large mesh size intended to reduce such bycatch compared to 1991

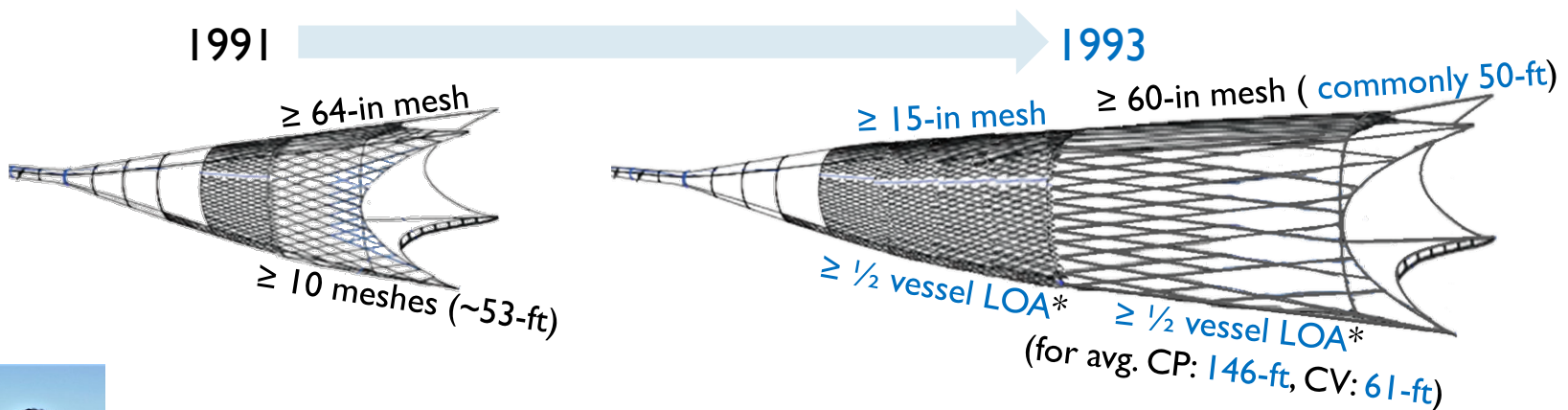

PERFORMANCE STANDARD

- **Performance standard does not appear to be meeting the objective as a means of “*discouraging or preventing trawl operations on the sea bed*”**
 - Reported contact of 20-100% used in Fishing Effects models
 - Large mesh (50-ft common) was explicitly designed to reduce bycatch
- **Logistical Challenges**
 - OLE only learns about performance standard violations from observers
 - Most crab observed in the forward portions of the net (outside of sample)
 - On-deck challenges for observer (dangers, limited view, determining whole or partial crab, and determining “at any particular time”)
- **Is seafloor contact important?**
 - Areas such as RKCSA prohibit non-pelagic trawling, but allow pelagic
 - Impacts of pelagic trawl seafloor contact on RKC are relatively unknown
 - If important, technology (sonar, echo sounder, tilt sensors, or others) may provide a potential path forward with proper testing and development



Questions?

